

# The Combined Approach to Query Answering in Horn-ALCHOIQ

David Carral, Irina Dragoste, Markus Krötzsch  
Knowledge-Based Systems Group at

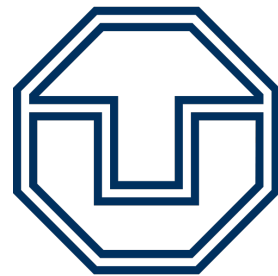

**TECHNISCHE  
UNIVERSITÄT  
DRESDEN**

# The Combined Approach

Conjunctive query

TBox

ABox

# The Combined Approach

## 1. Materialisation Step

Conjunctive query

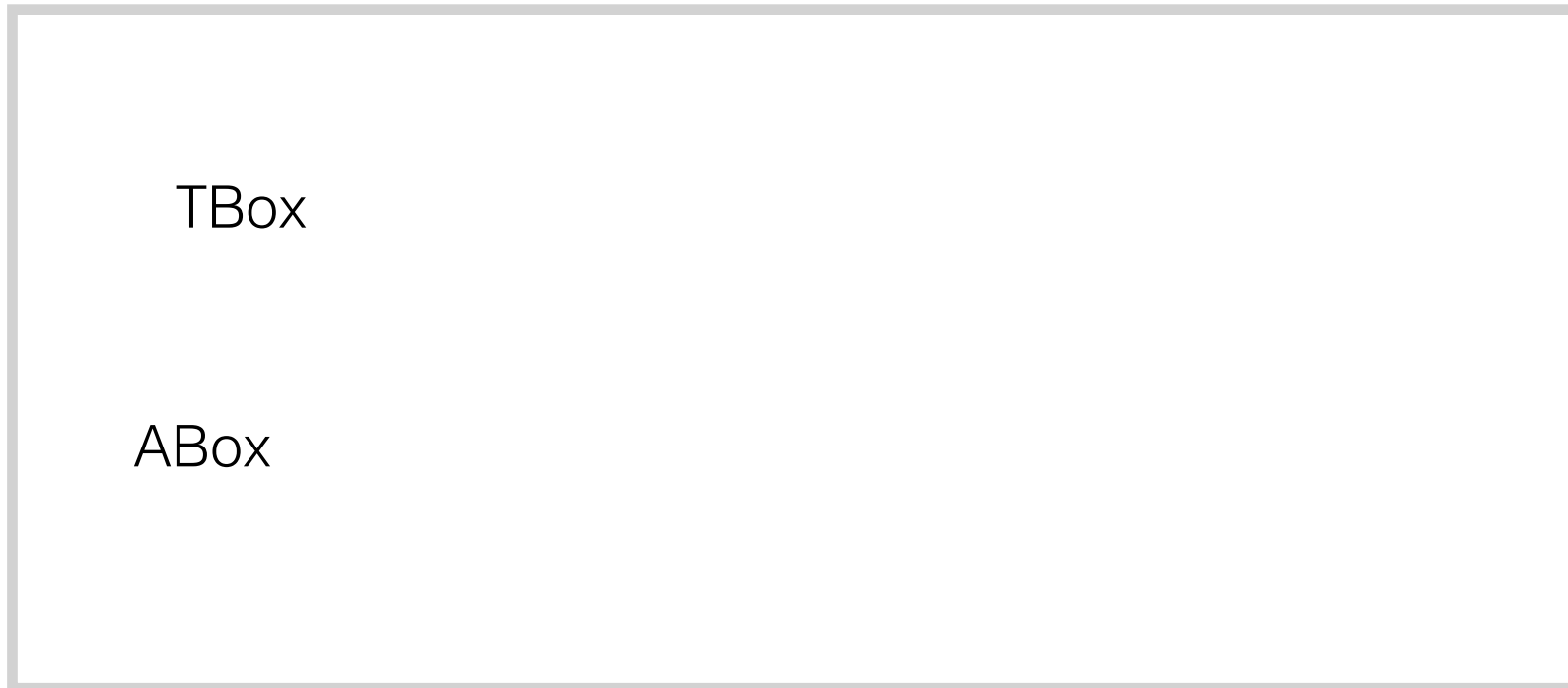

# The Combined Approach

## 1. Materialisation Step

Conjunctive query



# The Combined Approach

## 1. Materialisation Step

Conjunctive query

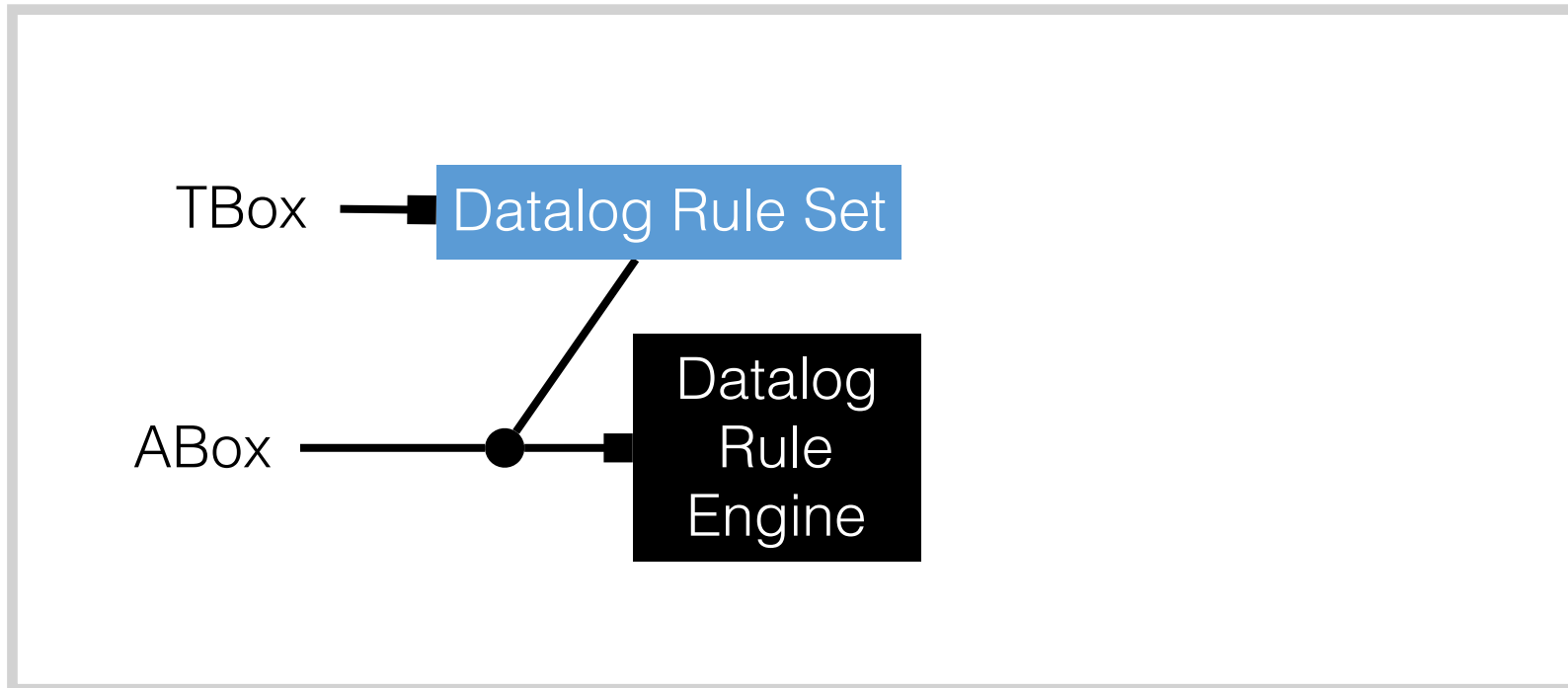

# The Combined Approach

## 1. Materialisation Step

Conjunctive query

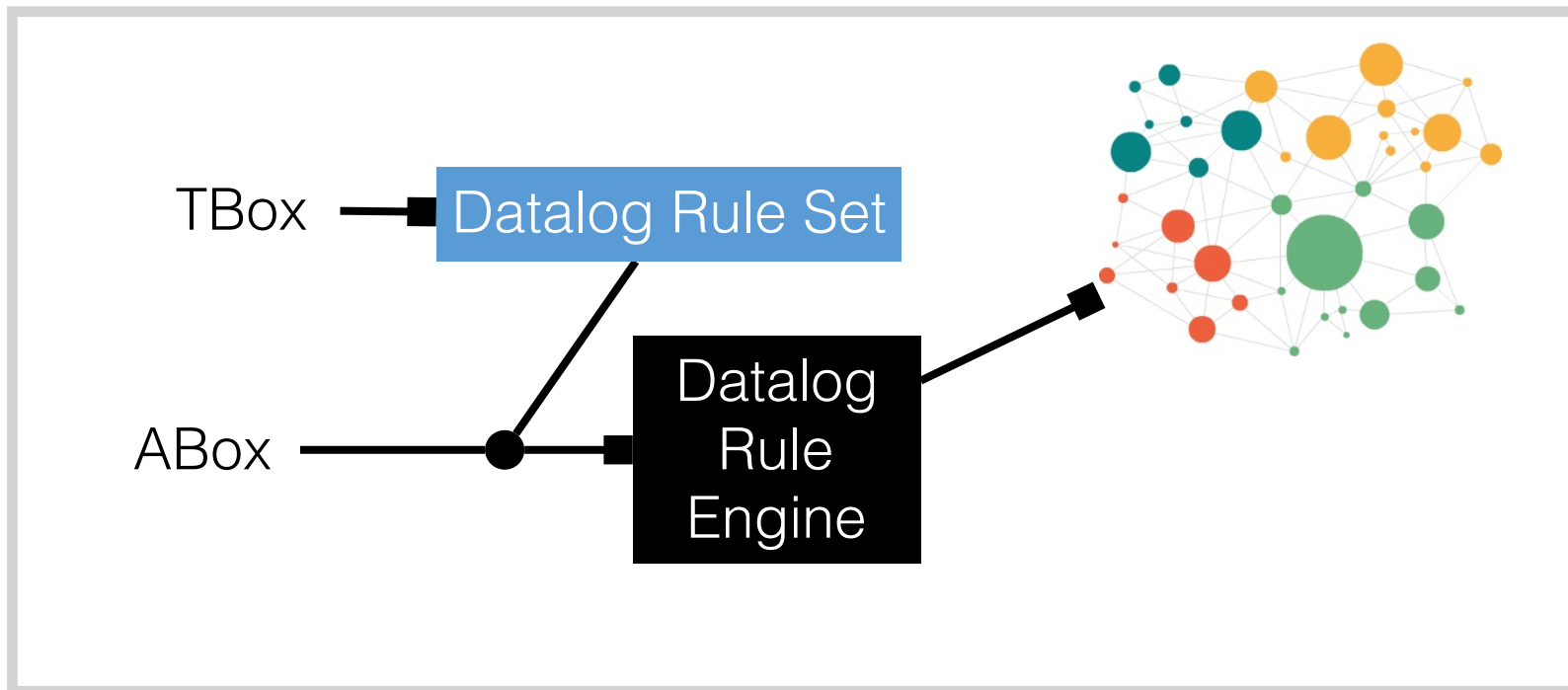

# The Combined Approach

## 1. Materialisation Step

Conjunctive query

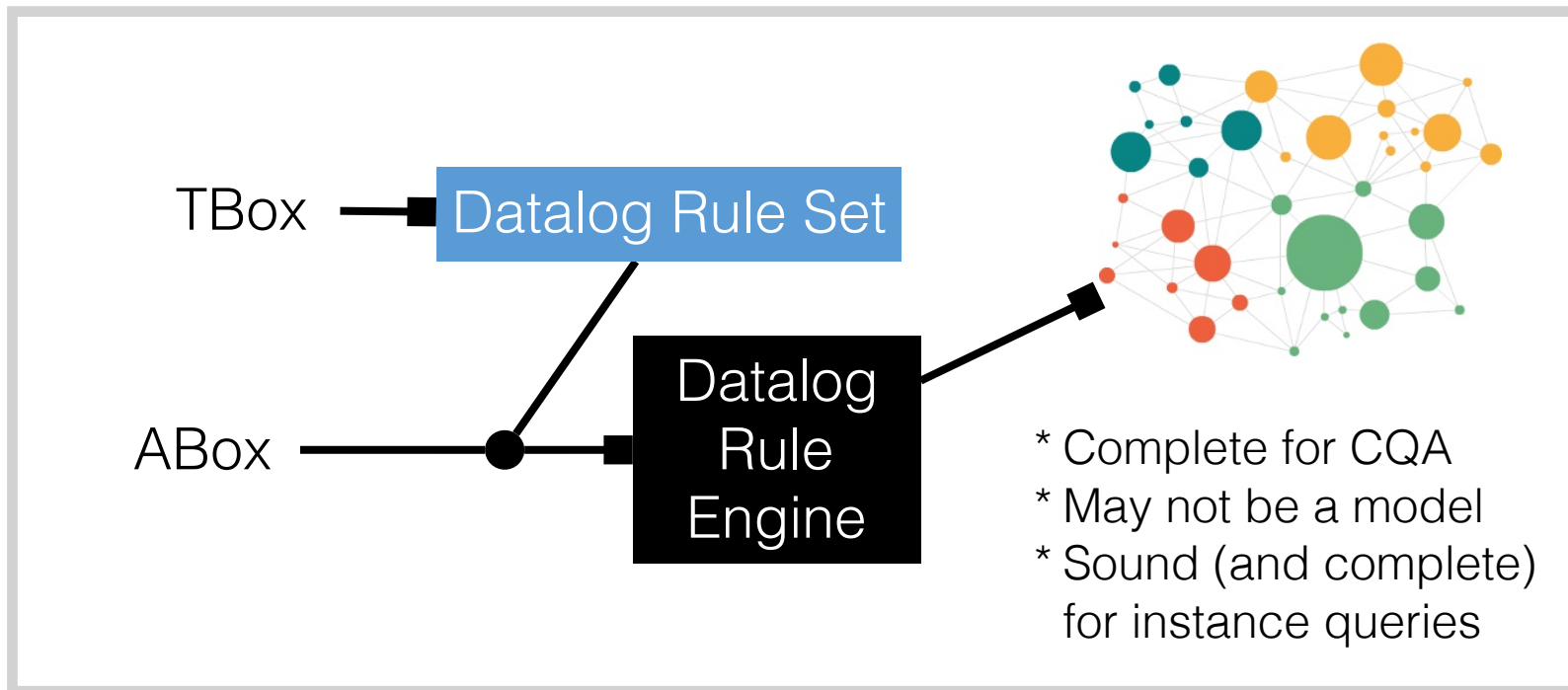

# The Combined Approach

## 1. Materialisation Step

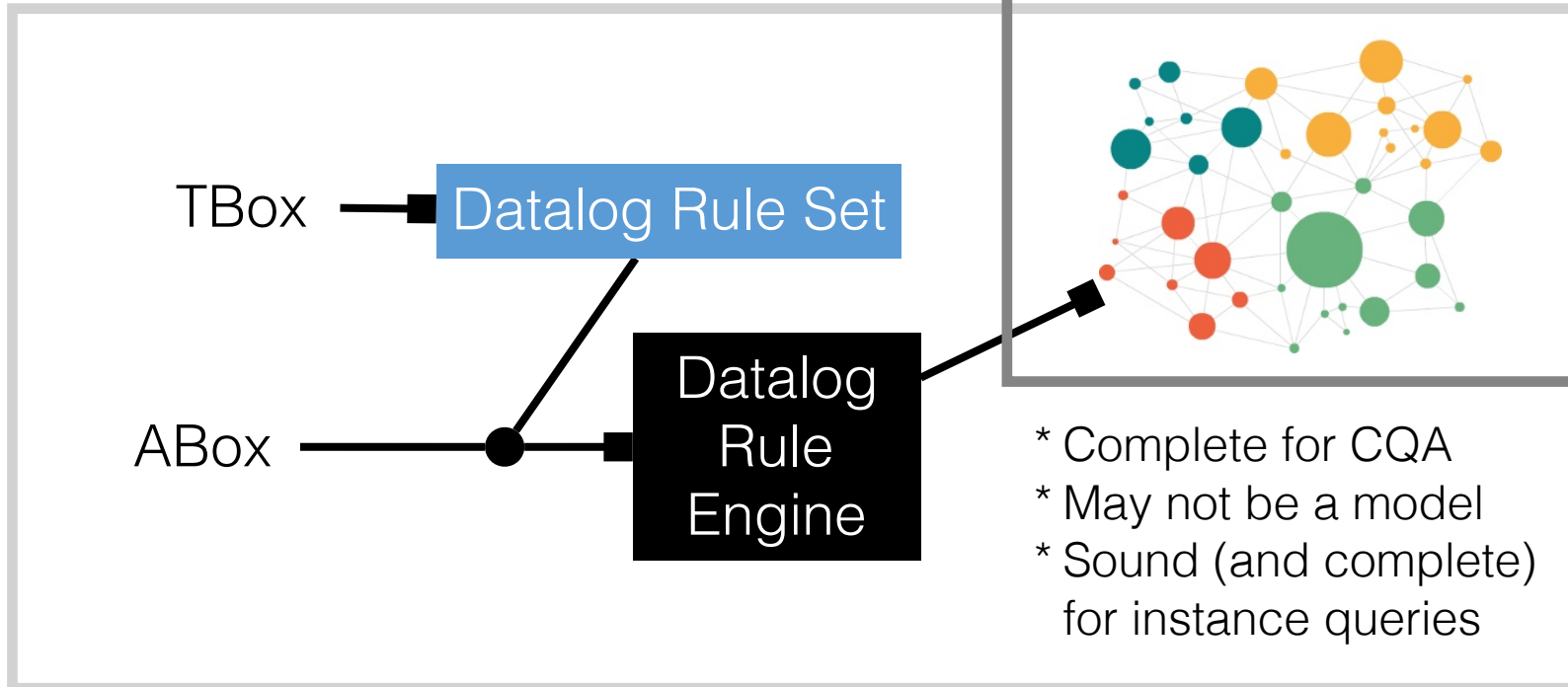

## 2. Filtration Step

Conjunctive query

- \* Complete for CQA
- \* May not be a model
- \* Sound (and complete) for instance queries



# The Combined Approach

## 1. Materialisation Step

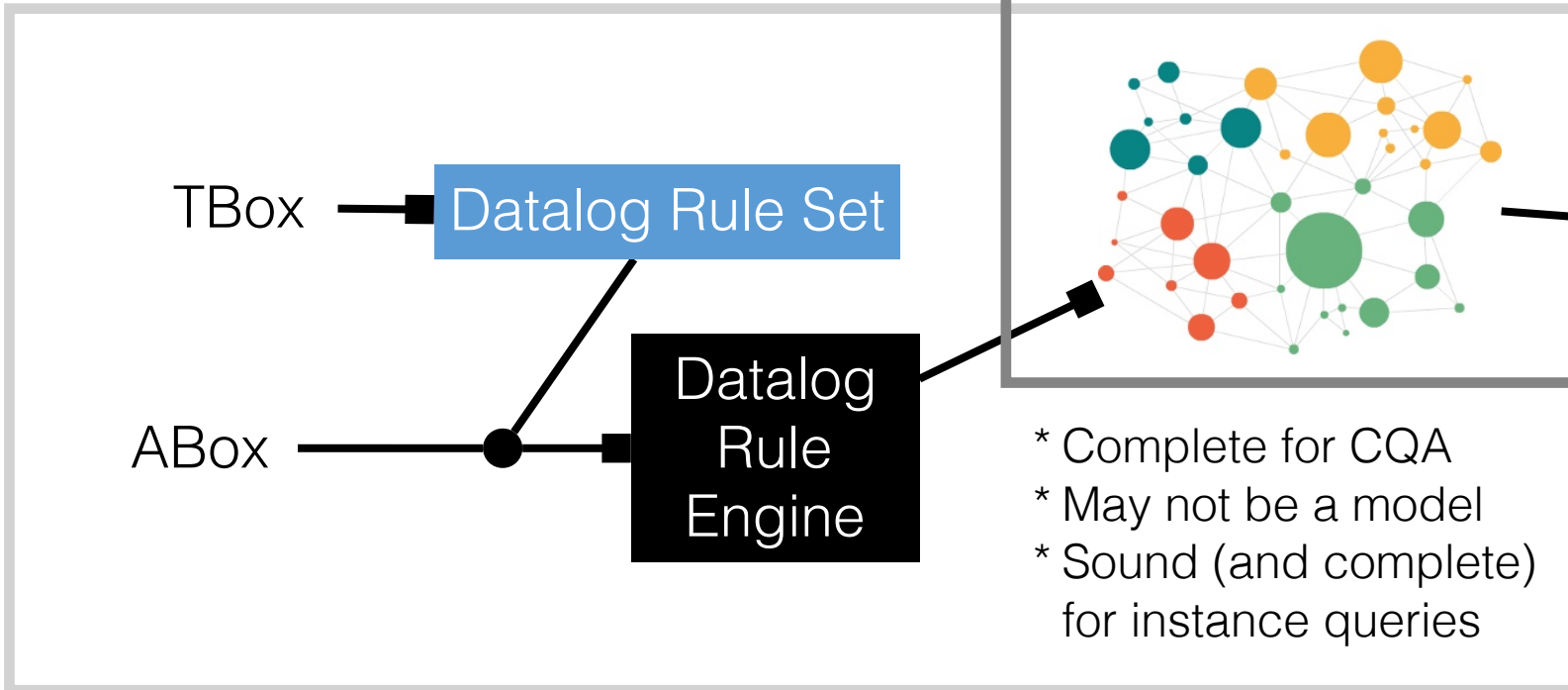

## 2. Filtration Step

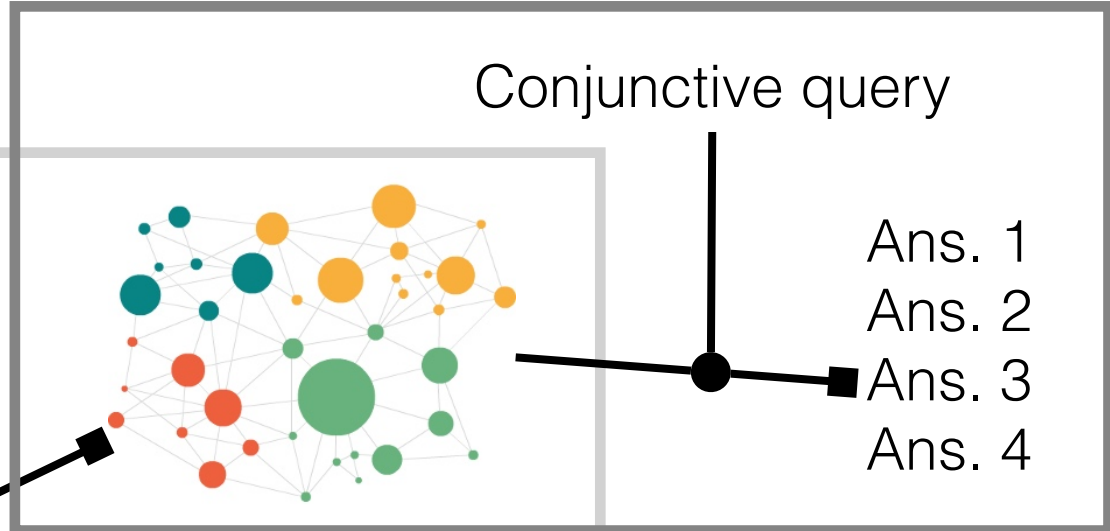

# The Combined Approach

## 1. Materialisation Step

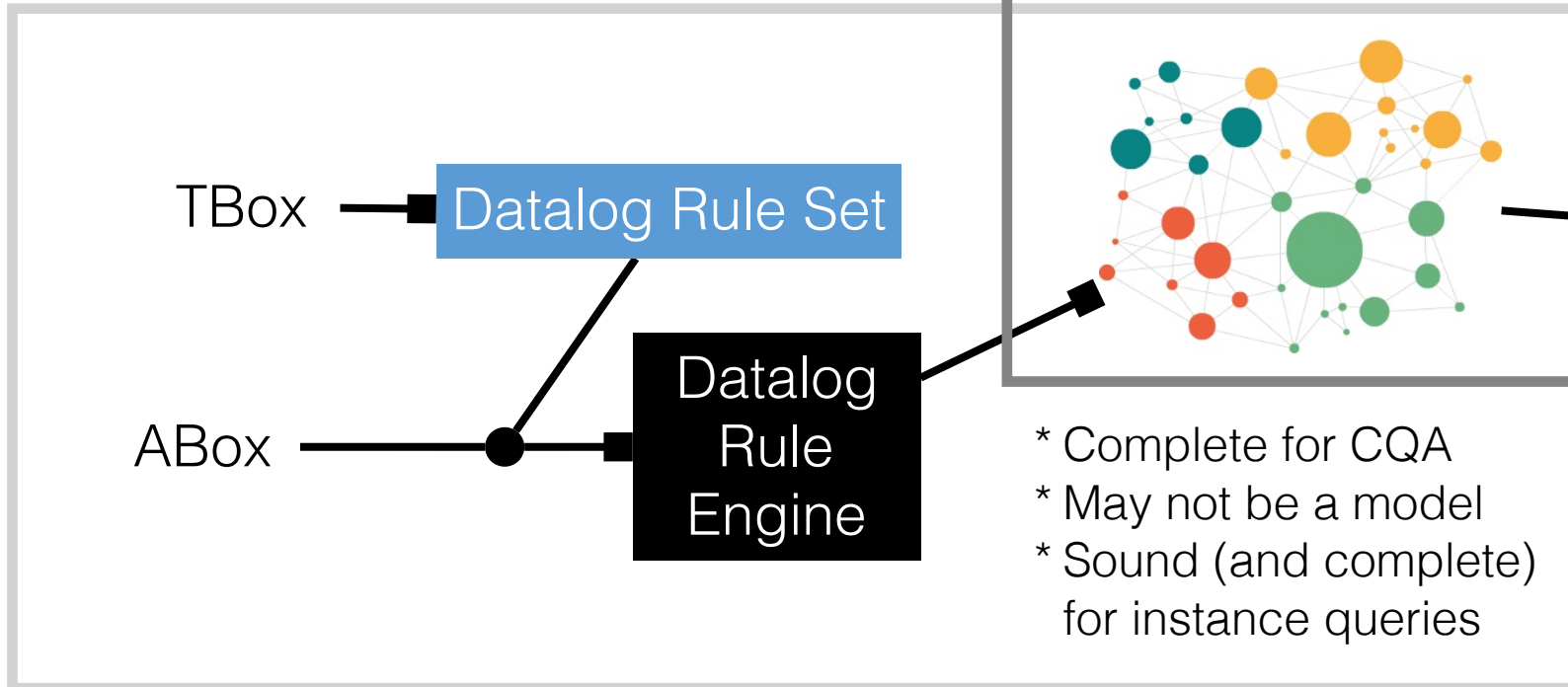

## 2. Filtration Step

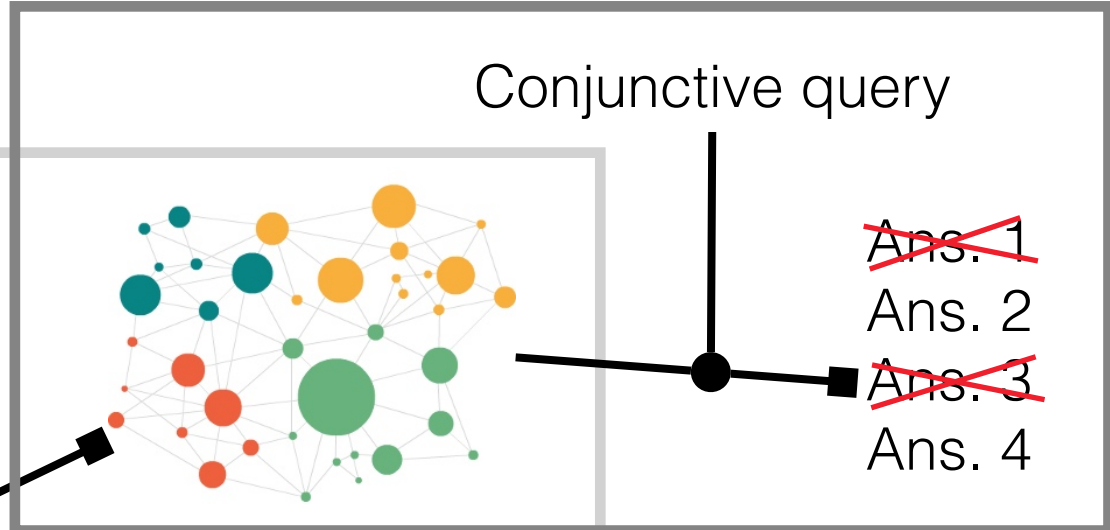

# The Combined Approach for Horn-ALCHOIQ

$$C_1 \sqcap \dots \sqcap C_n \sqsubseteq D$$

$$\exists R. C \sqsubseteq D$$

$$C \sqsubseteq \exists R. D$$

$$C \sqsubseteq \leq 1 R. D$$

$$C \sqsubseteq \{a\}$$

$$R \sqsubseteq S$$

$$R_1 \sqcap \dots \sqcap R_n \sqsubseteq \perp$$

$$R(a, b)$$

$$A(a)$$

# The Materialisation Step

# Materialisation Step: EL

$$C_1 \sqcap \dots \sqcap C_n \sqsubseteq D \quad \mapsto \quad C_1(x) \wedge \dots \wedge C_n(x) \rightarrow D(x)$$

$$\exists R. C \sqsubseteq D \quad \mapsto \quad R(x, y) \wedge C(y) \rightarrow D(x)$$

$$C \sqsubseteq \exists R. D \quad \mapsto \quad C(x) \rightarrow R(x, t_D) \wedge D(t_D)$$

$$R \sqsubseteq S \quad \mapsto \quad R(x, y) \rightarrow S(x, y)$$

$$C(a) \quad \mapsto \quad C(a)$$

$$R(a, b) \quad \mapsto \quad R(a, b)$$

# Materialisation Step: EL

$$C_1 \sqcap \dots \sqcap C_n \sqsubseteq D \quad \mapsto \quad C_1(x) \wedge \dots \wedge C_n(x) \rightarrow D(x)$$

$$\exists R. C \sqsubseteq D \quad \mapsto \quad R(x, y) \wedge C(y) \rightarrow D(x)$$

$$C \sqsubseteq \exists R. D \quad \mapsto \quad C(x) \rightarrow R(x, t_D) \wedge D(t_D)$$

$$R \sqsubseteq S \quad \mapsto \quad R(x, y) \rightarrow S(x, y)$$

$$C(a) \quad \mapsto \quad C(a)$$

$$R(a, b) \quad \mapsto \quad R(a, b)$$

# Materialisation Step: EL

$C \sqsubseteq \exists R . D$       $C(a)$

$D \sqsubseteq \exists S . C$

$\exists S . C \sqsubseteq E$

$\exists R . E \sqsubseteq F$

# Materialisation Step: EL

$C \sqsubseteq \exists R . D$       $C(a)$

$D \sqsubseteq \exists S . C$

$\exists S . C \sqsubseteq E$

$\exists R . E \sqsubseteq F$

●  $a : C$



# Materialisation Step: EL

$C \sqsubseteq \exists R . D$       $C(a)$

$D \sqsubseteq \exists S . C$

$\exists S . C \sqsubseteq E$

$\exists R . E \sqsubseteq F$

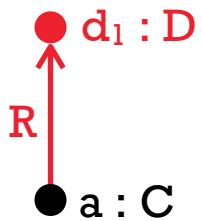

# Materialisation Step: EL

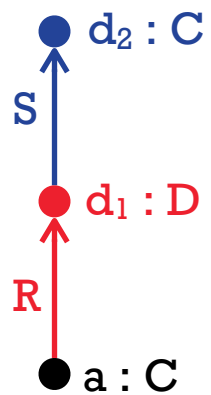

$$C \sqsubseteq \exists R . D \quad C(a)$$

$$D \sqsubseteq \exists S . C$$

$$\exists S . C \sqsubseteq E$$

$$\exists R . E \sqsubseteq F$$

# Materialisation Step: EL

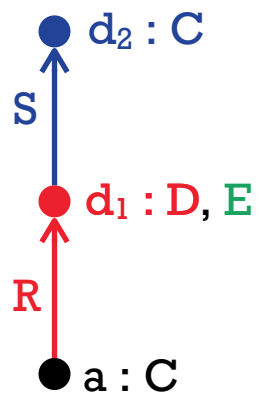

$$C \sqsubseteq \exists R . D \quad C(a)$$

$$D \sqsubseteq \exists S . C$$

$$\exists S . C \sqsubseteq E$$

$$\exists R . E \sqsubseteq F$$

# Materialisation Step: EL

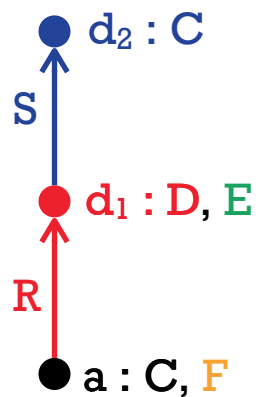

$$C \sqsubseteq \exists R . D \quad C(a)$$

$$D \sqsubseteq \exists S . C$$

$$\exists S . C \sqsubseteq E$$

$$\exists R . E \sqsubseteq F$$

# Materialisation Step: EL

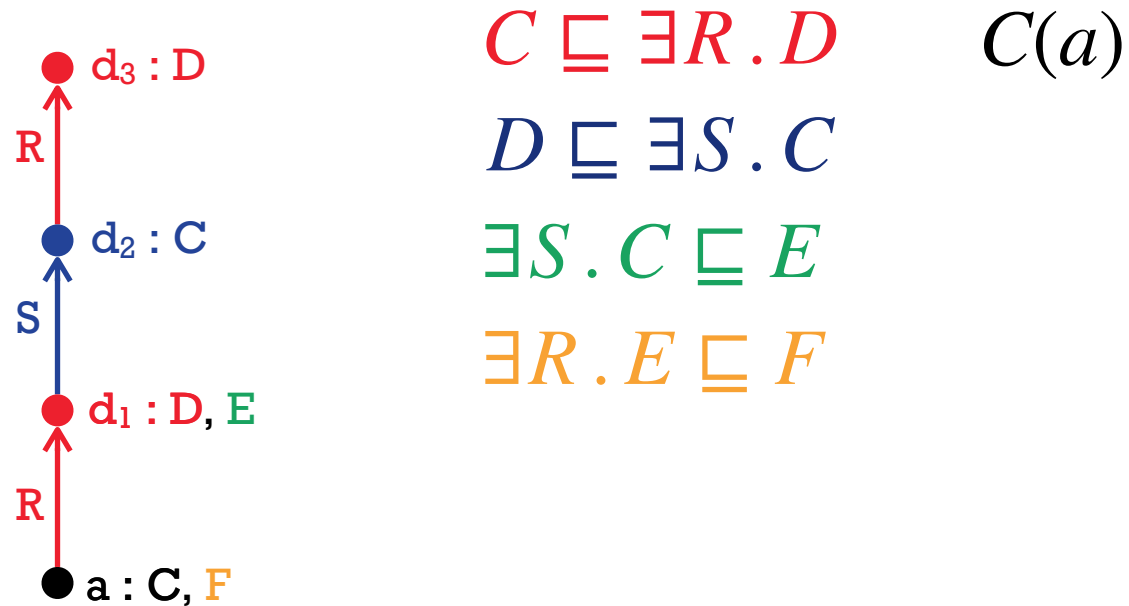

# Materialisation Step: EL

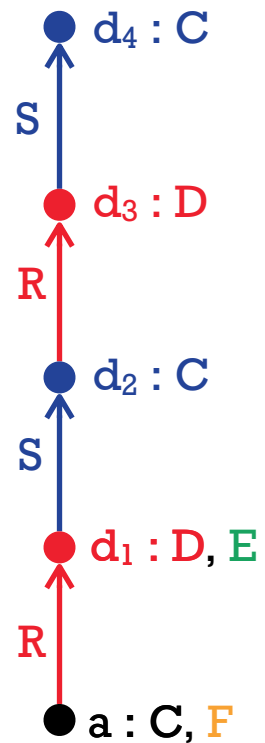

$$C \sqsubseteq \exists R . D \quad C(a)$$

$$D \sqsubseteq \exists S . C$$

$$\exists S . C \sqsubseteq E$$

$$\exists R . E \sqsubseteq F$$

# Materialisation Step: EL

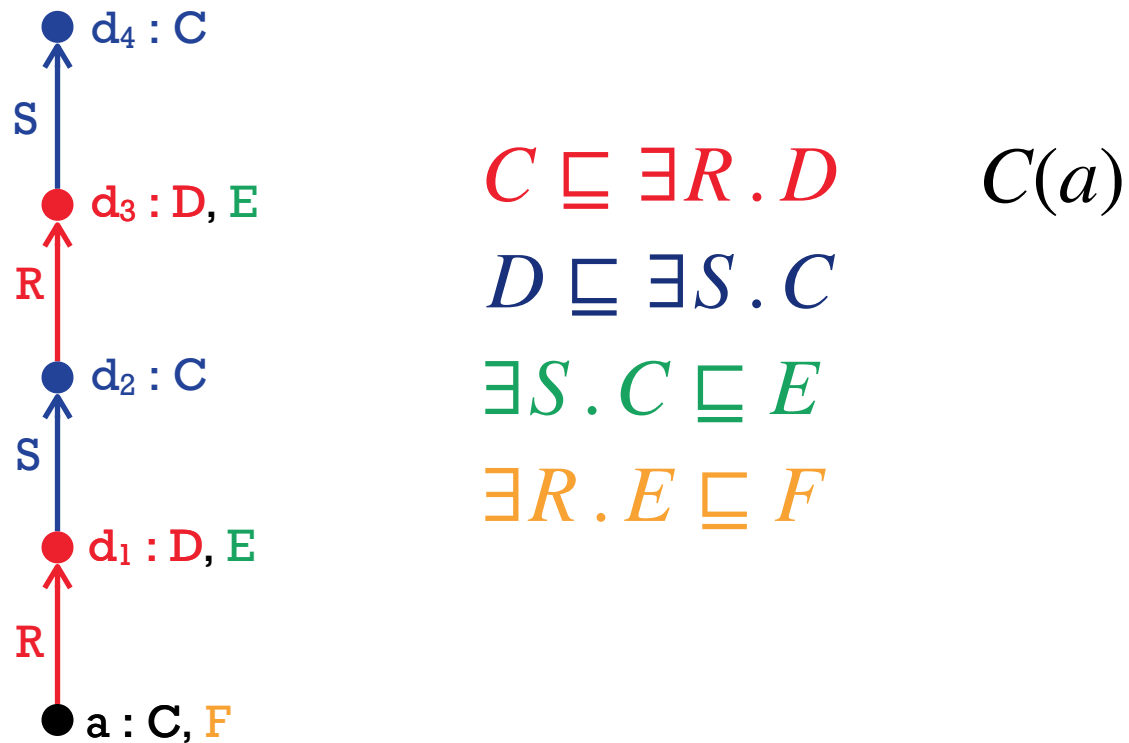

# Materialisation Step: EL





# Materialisation Step: EL

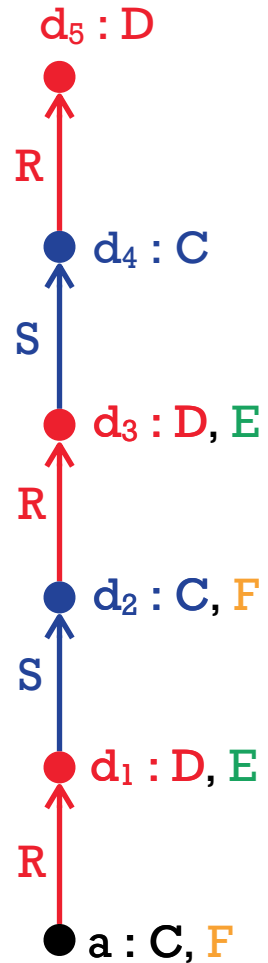

$$C \sqsubseteq \exists R . D \quad C(a)$$

$$D \sqsubseteq \exists S . C$$

$$\exists S . C \sqsubseteq E$$

$$\exists R . E \sqsubseteq F$$

# Materialisation Step: EL

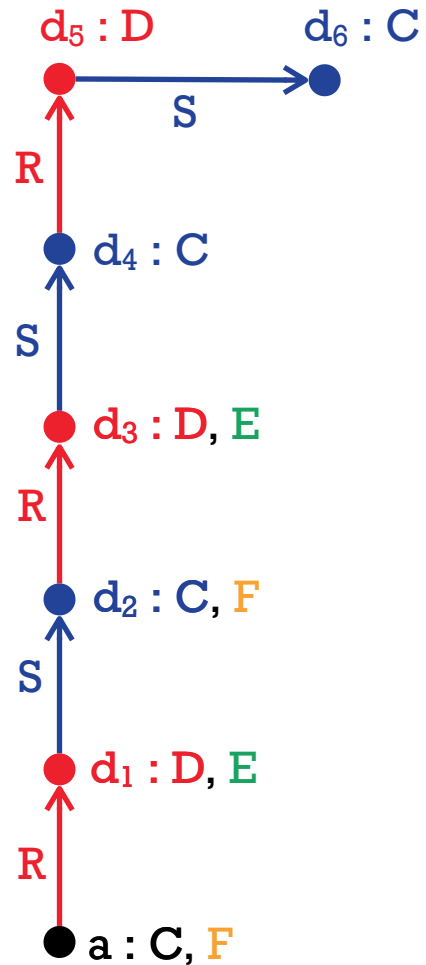

$$C \sqsubseteq \exists R . D \quad C(a)$$

$$D \sqsubseteq \exists S . C$$

$$\exists S . C \sqsubseteq E$$

$$\exists R . E \sqsubseteq F$$

# Materialisation Step: EL

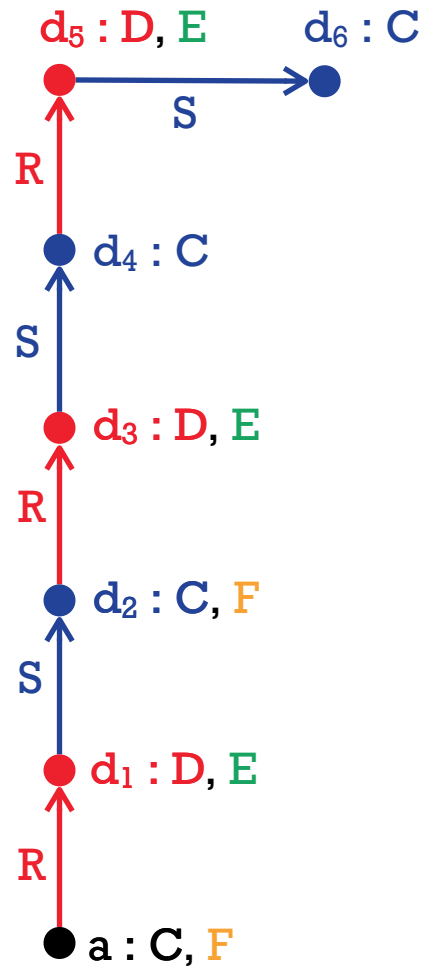

$$C \sqsubseteq \exists R . D \quad C(a)$$

$$D \sqsubseteq \exists S . C$$

$$\exists S . C \sqsubseteq E$$

$$\exists R . E \sqsubseteq F$$

# Materialisation Step: EL

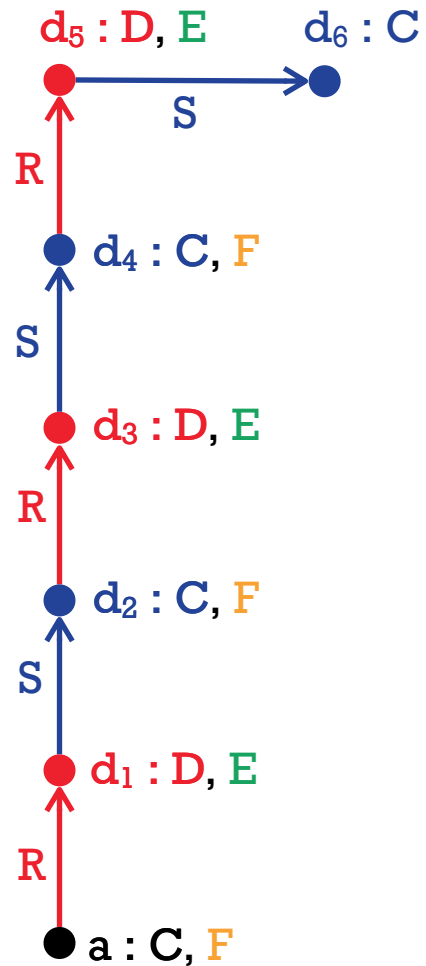

$$C \sqsubseteq \exists R . D \quad C(a)$$

$$D \sqsubseteq \exists S . C$$

$$\exists S . C \sqsubseteq E$$

$$\exists R . E \sqsubseteq F$$

# Materialisation Step: EL

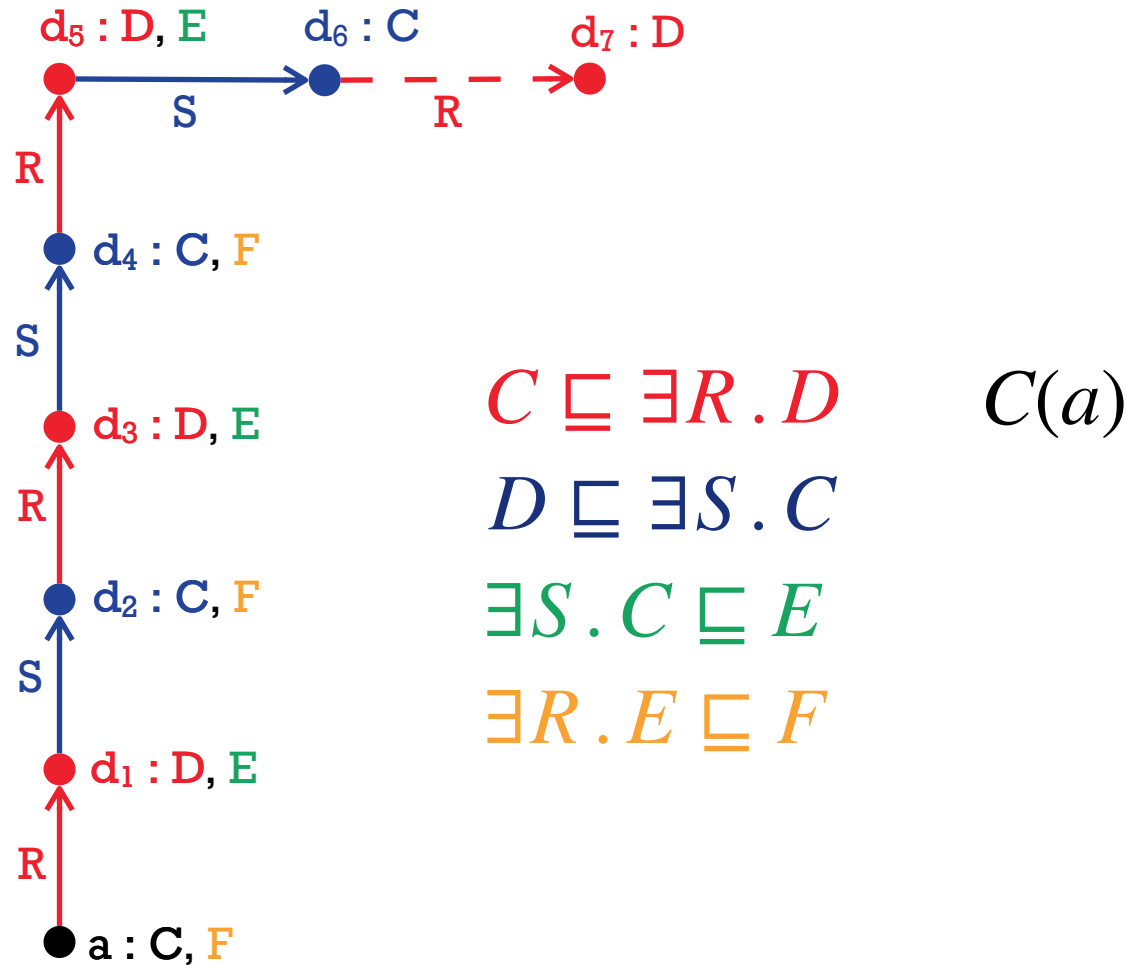

# Materialisation Step: EL

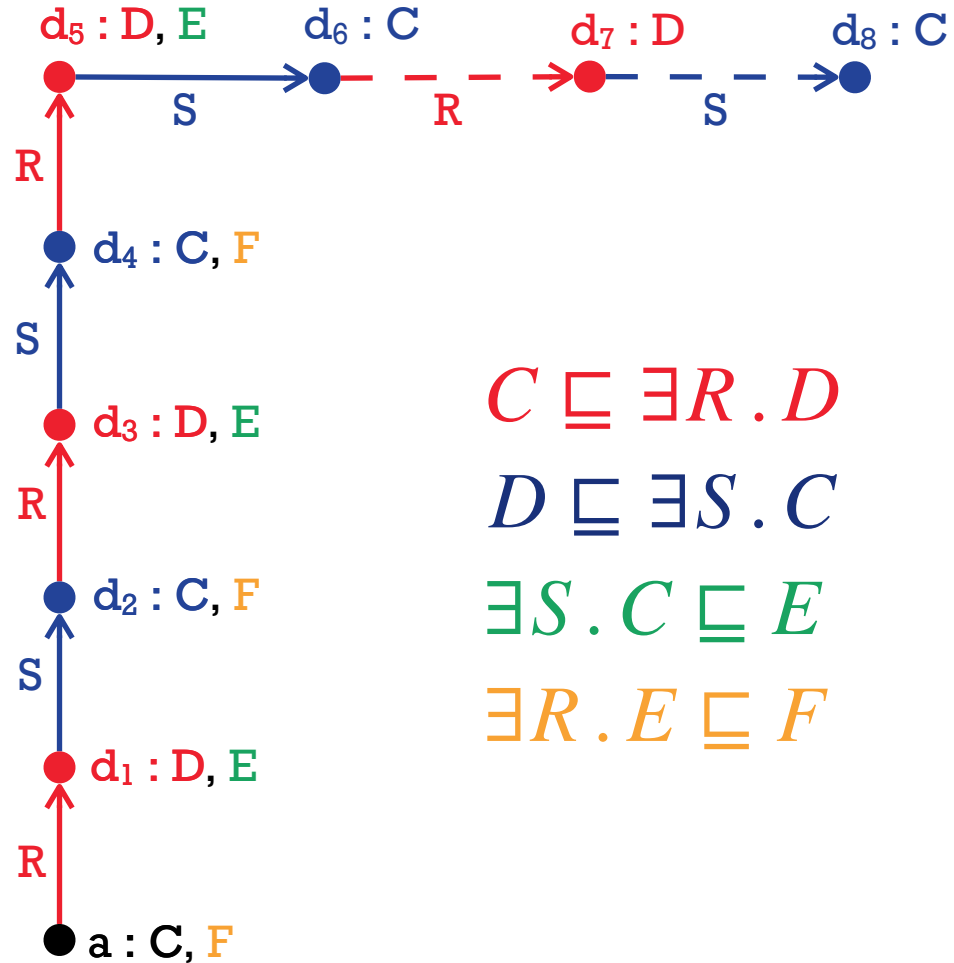

$$C \sqsubseteq \exists R . D \quad C(a)$$

$$D \sqsubseteq \exists S . C$$

$$\exists S . C \sqsubseteq E$$

$$\exists R . E \sqsubseteq F$$

# Materialisation Step: EL

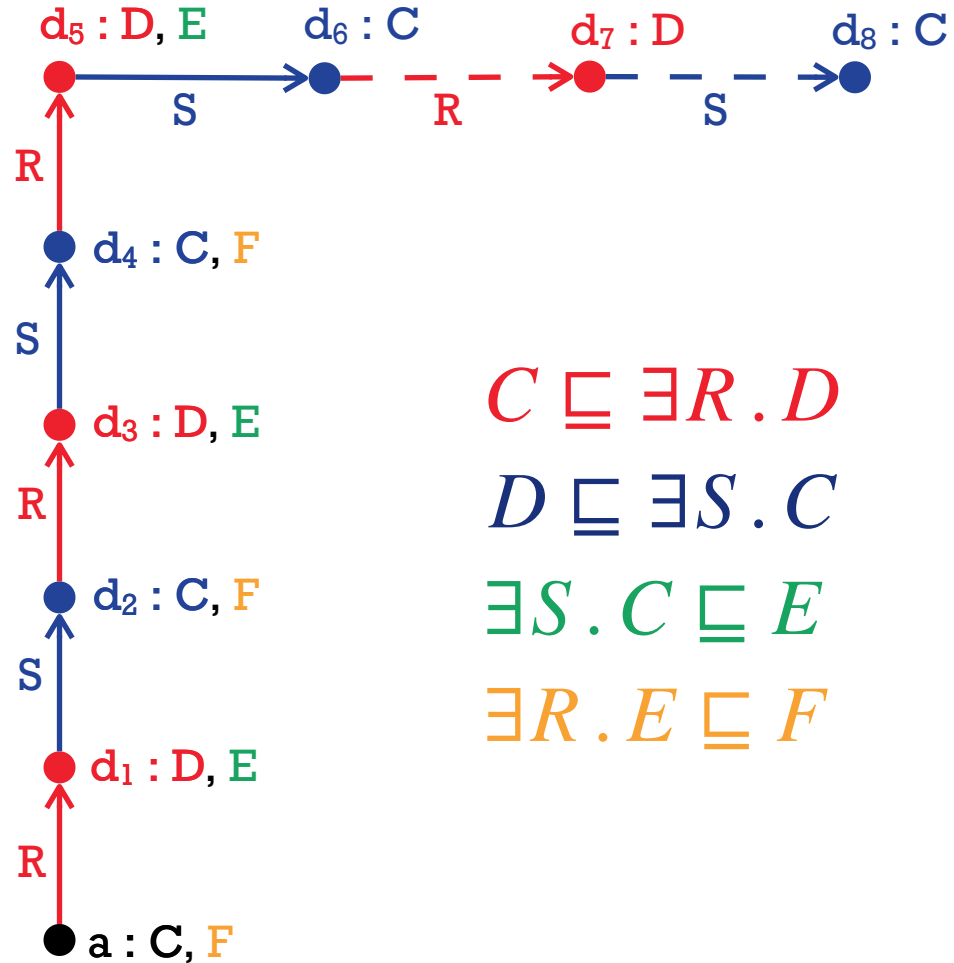

$$C \sqsubseteq \exists R. D$$

$C(a)$

$$D \sqsubseteq \exists S. C$$

$$\exists S. C \sqsubseteq E$$

$$\exists R. E \sqsubseteq F$$

$$C(x) \rightarrow R(x, t_D) \wedge D(t_D)$$

$$D(x) \rightarrow S(x, t_C) \wedge C(t_C)$$

$$S(x, y) \wedge C(y) \rightarrow E(x)$$

$$R(x, y) \wedge E(y) \rightarrow F(x)$$

# Materialisation Step: EL

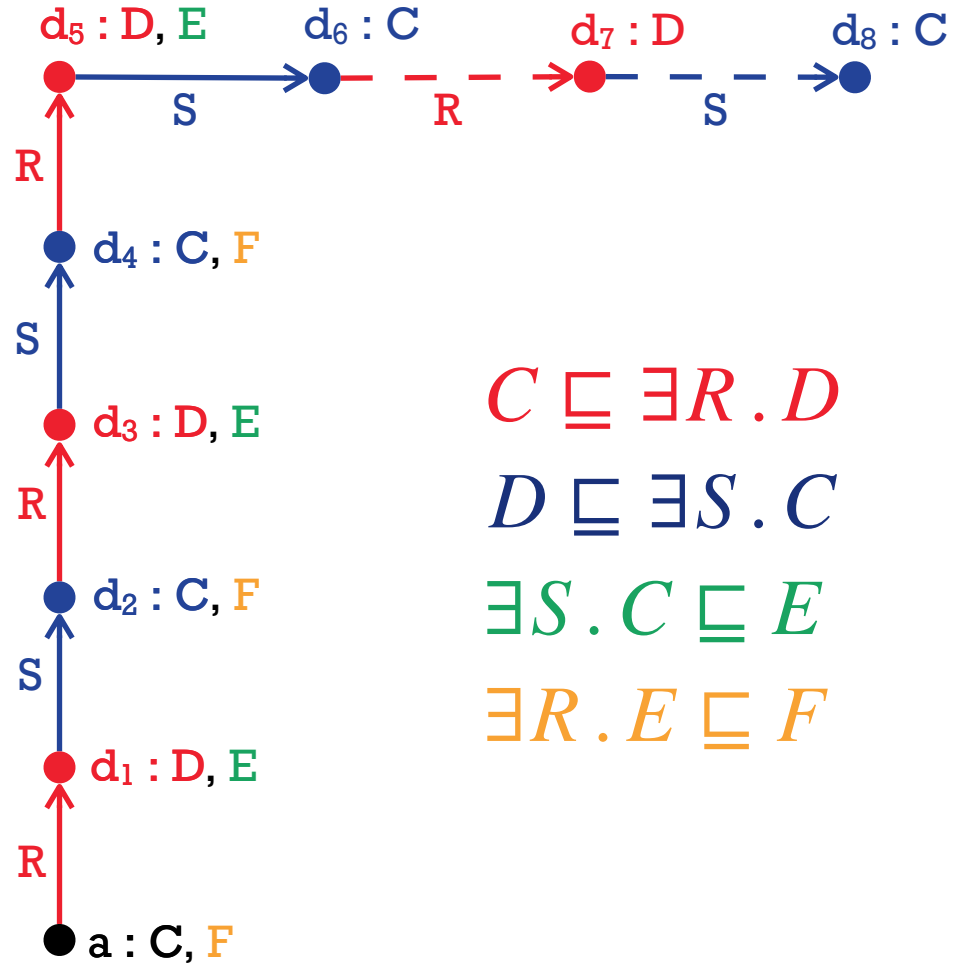

$$C \sqsubseteq \exists R . D$$

$C(a)$

$$D \sqsubseteq \exists S . C$$

$$\exists S . C \sqsubseteq E$$

$$\exists R . E \sqsubseteq F$$

$$C(x) \rightarrow R(x, t_D) \wedge D(t_D)$$

$$D(x) \rightarrow S(x, t_C) \wedge C(t_C)$$

$$S(x, y) \wedge C(y) \rightarrow E(x)$$

$$R(x, y) \wedge E(y) \rightarrow F(x)$$

$\bullet$   
 $a : C$



# Materialisation Step: EL

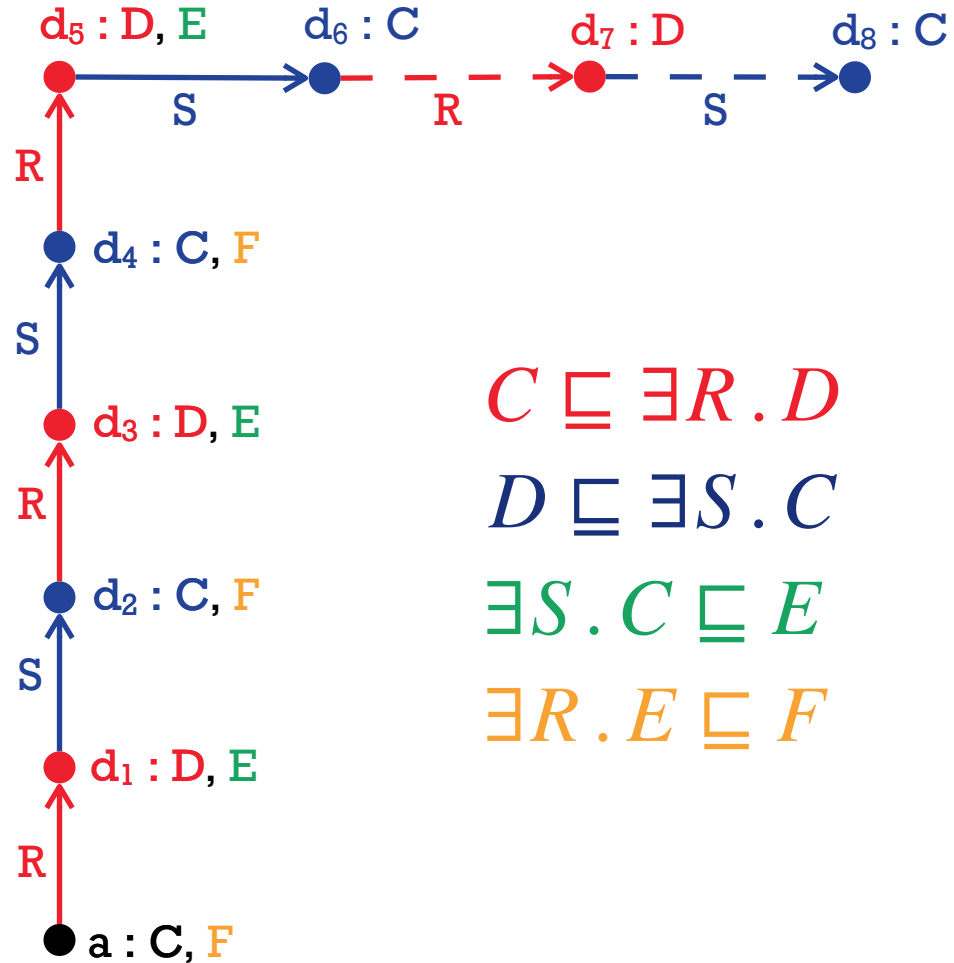

$$C \sqsubseteq \exists R . D$$

$C(a)$

$$D \sqsubseteq \exists S . C$$

$$\exists S . C \sqsubseteq E$$

$$\exists R . E \sqsubseteq F$$

$$C(x) \rightarrow R(x, t_D) \wedge D(t_D)$$

$$D(x) \rightarrow S(x, t_C) \wedge C(t_C)$$

$$S(x, y) \wedge C(y) \rightarrow E(x)$$

$$R(x, y) \wedge E(y) \rightarrow F(x)$$

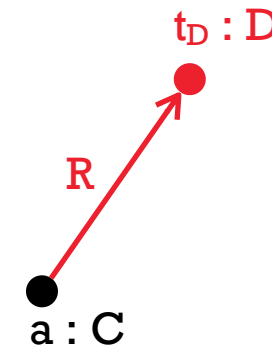

# Materialisation Step: EL

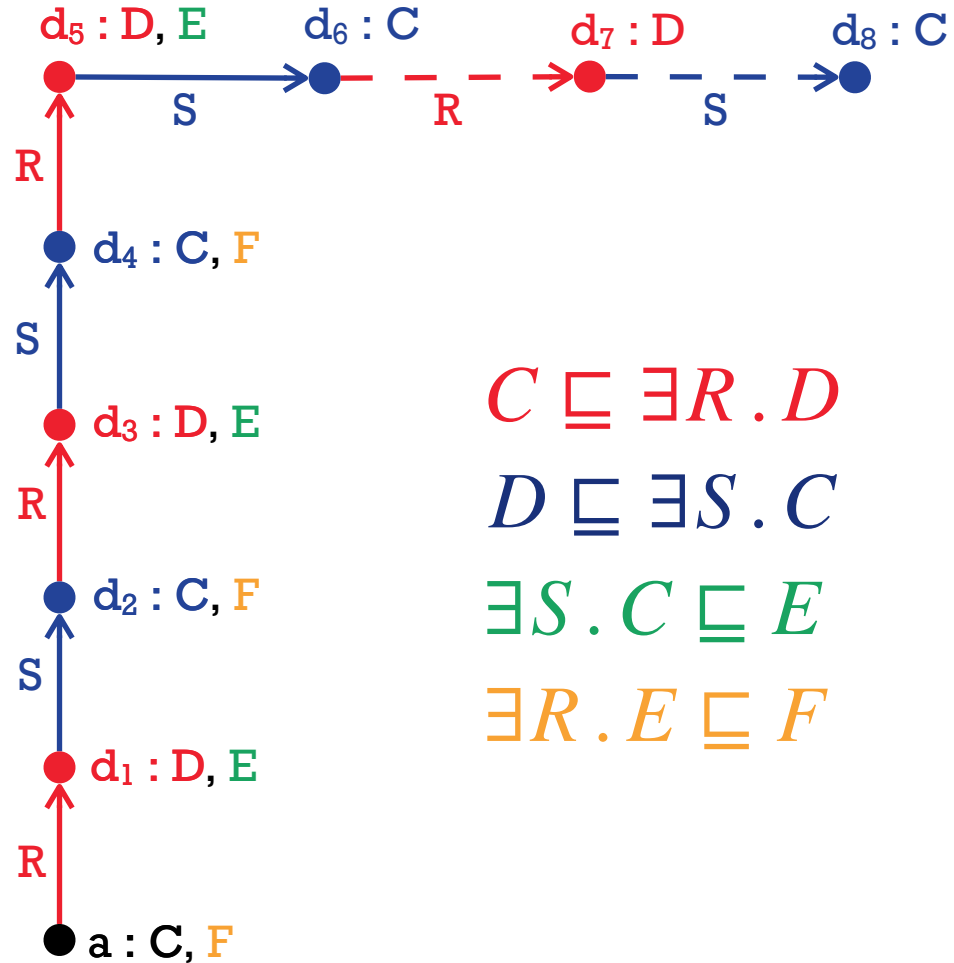

$$C \sqsubseteq \exists R . D$$

$C(a)$

$$D \sqsubseteq \exists S . C$$

$$\exists S . C \sqsubseteq E$$

$$\exists R . E \sqsubseteq F$$

$$C(x) \rightarrow R(x, t_D) \wedge D(t_D)$$

$$D(x) \rightarrow S(x, t_C) \wedge C(t_C)$$

$$S(x, y) \wedge C(y) \rightarrow E(x)$$

$$R(x, y) \wedge E(y) \rightarrow F(x)$$

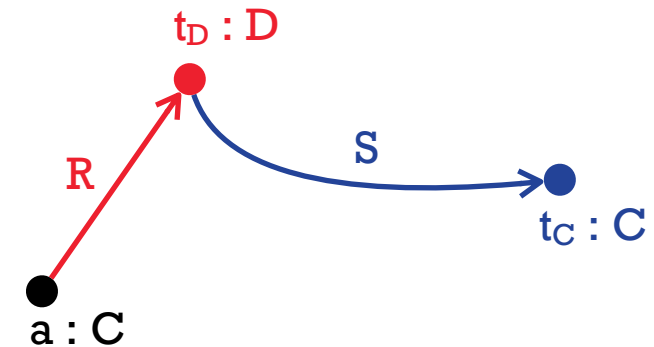

# Materialisation Step: EL

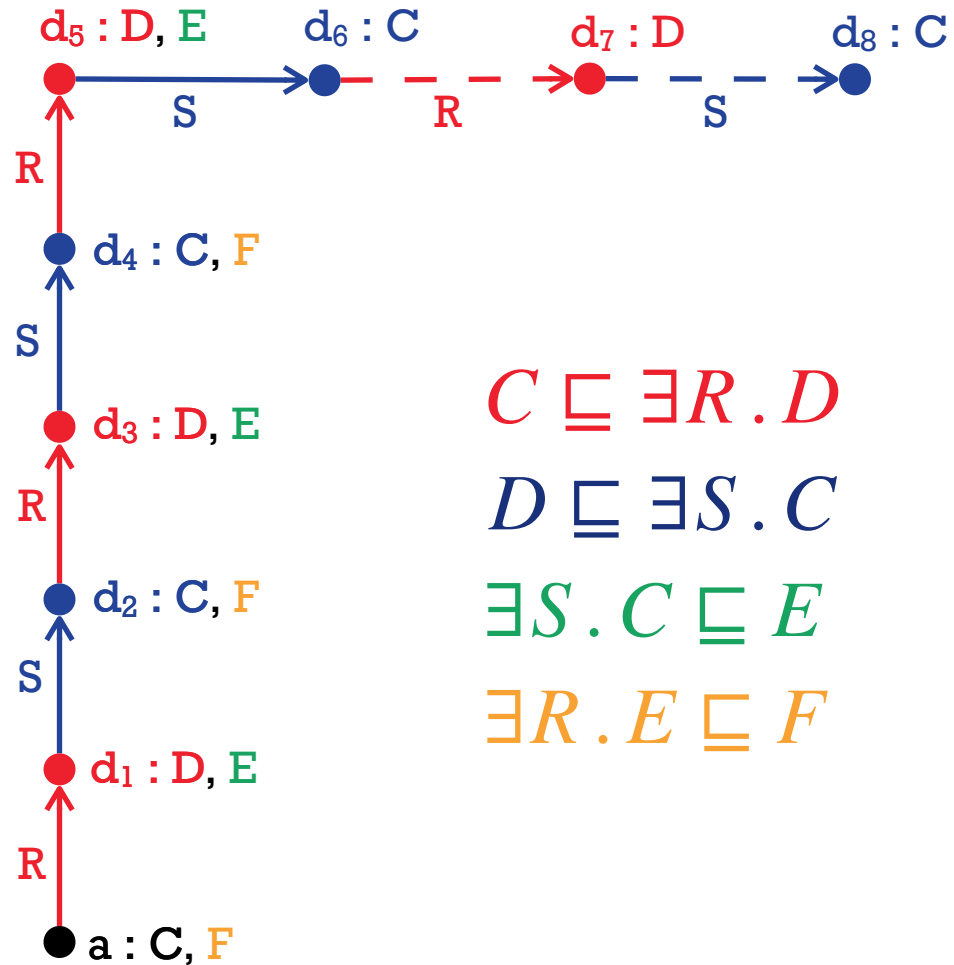

$$C \sqsubseteq \exists R . D$$

$C(a)$

$$D \sqsubseteq \exists S . C$$

$$\exists S . C \sqsubseteq E$$

$$\exists R . E \sqsubseteq F$$

$$C(x) \rightarrow R(x, t_D) \wedge D(t_D)$$

$$D(x) \rightarrow S(x, t_C) \wedge C(t_C)$$

$$S(x, y) \wedge C(y) \rightarrow E(x)$$

$$R(x, y) \wedge E(y) \rightarrow F(x)$$

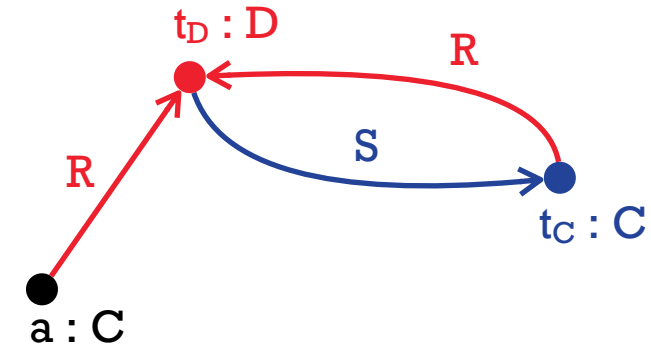

# Materialisation Step: EL

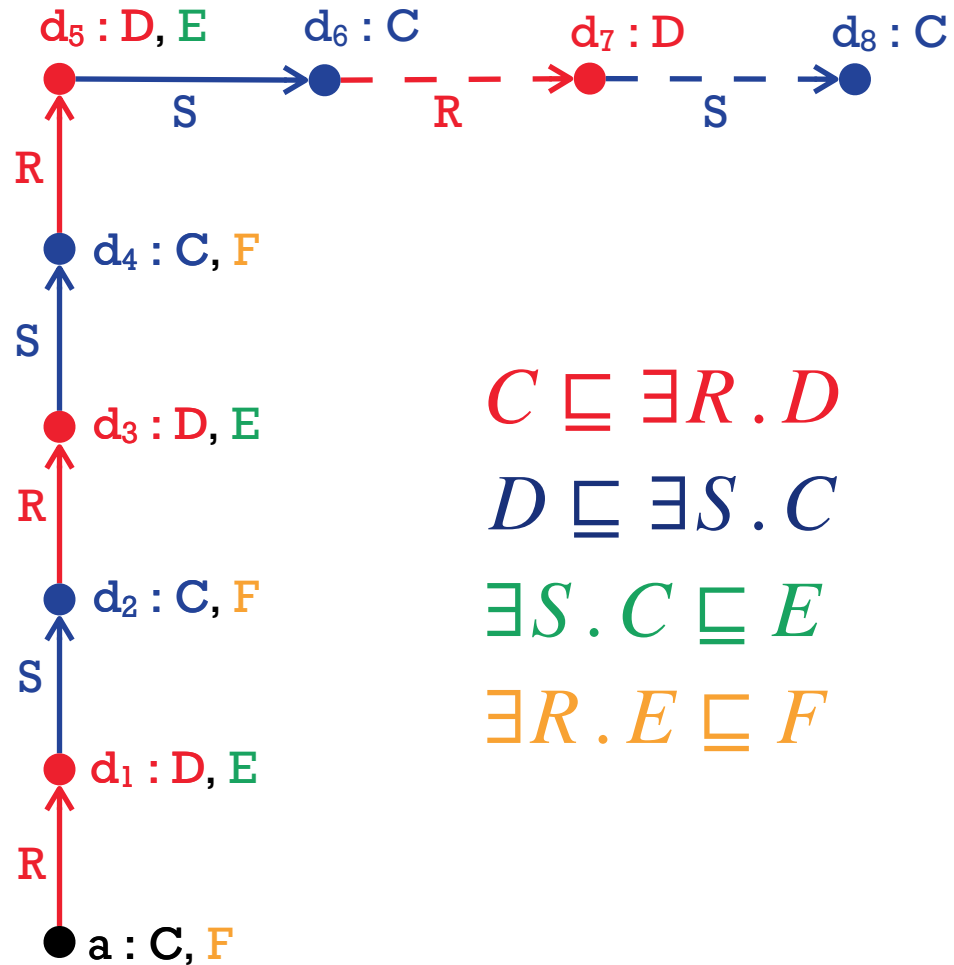

$$C \sqsubseteq \exists R . D$$

$C(a)$

$$D \sqsubseteq \exists S . C$$

$$\exists S . C \sqsubseteq E$$

$$\exists R . E \sqsubseteq F$$

$$C(x) \rightarrow R(x, t_D) \wedge D(t_D)$$

$$D(x) \rightarrow S(x, t_C) \wedge C(t_C)$$

$$S(x, y) \wedge C(y) \rightarrow E(x)$$

$$R(x, y) \wedge E(y) \rightarrow F(x)$$

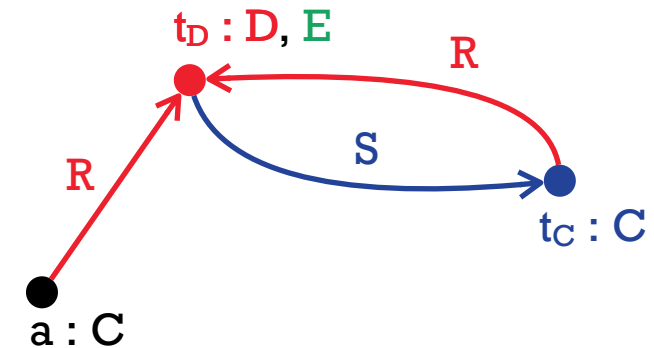

# Materialisation Step: EL

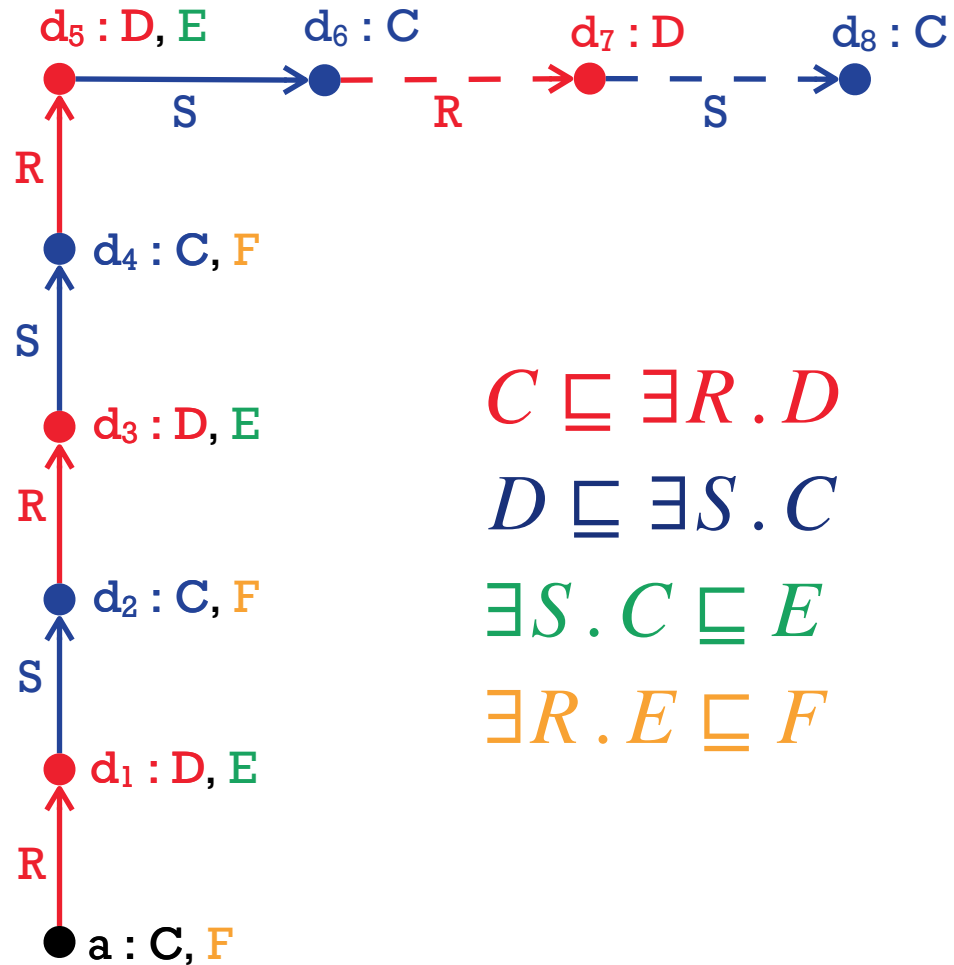

$$C \sqsubseteq \exists R . D$$

$C(a)$

$$D \sqsubseteq \exists S . C$$

$$\exists S . C \sqsubseteq E$$

$$\exists R . E \sqsubseteq F$$

$$C(x) \rightarrow R(x, t_D) \wedge D(t_D)$$

$$D(x) \rightarrow S(x, t_C) \wedge C(t_C)$$

$$S(x, y) \wedge C(y) \rightarrow E(x)$$

$$R(x, y) \wedge E(y) \rightarrow F(x)$$

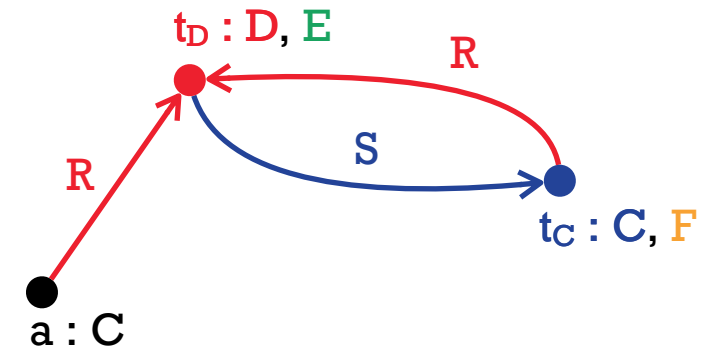

# Materialisation Step: EL

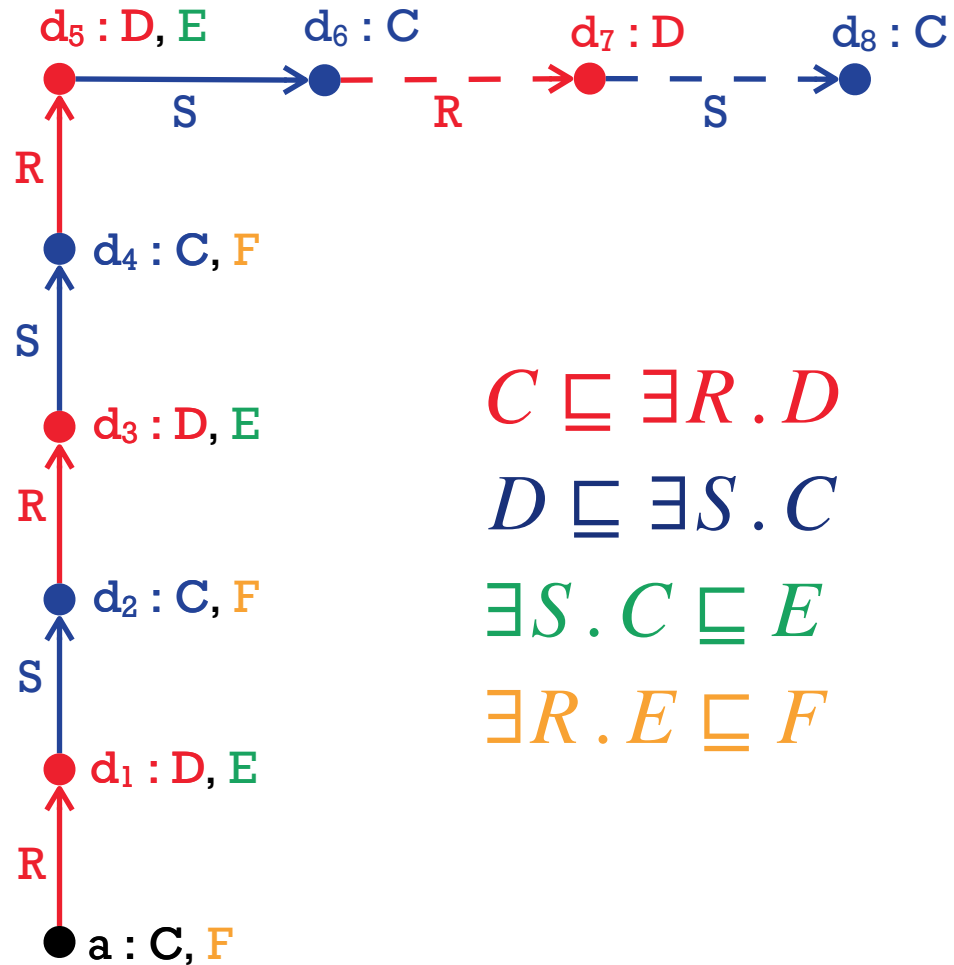

$$C \sqsubseteq \exists R . D$$

$C(a)$

$$D \sqsubseteq \exists S . C$$

$$\exists S . C \sqsubseteq E$$

$$\exists R . E \sqsubseteq F$$

$$C(x) \rightarrow R(x, t_D) \wedge D(t_D)$$

$$D(x) \rightarrow S(x, t_C) \wedge C(t_C)$$

$$S(x, y) \wedge C(y) \rightarrow E(x)$$

$$R(x, y) \wedge E(y) \rightarrow F(x)$$

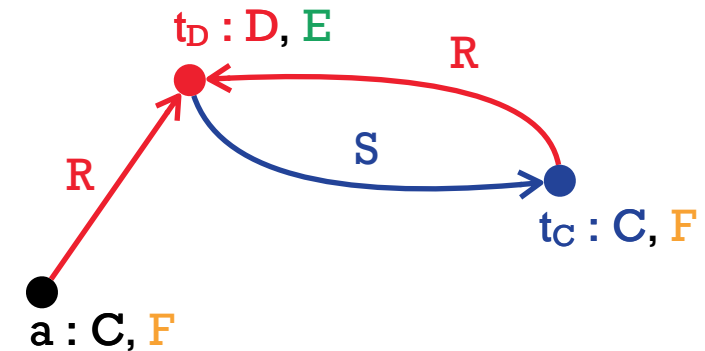

# Materialisation Step: (Horn-)ELI

$$C_1 \sqcap \dots \sqcap C_n \sqsubseteq D \quad \mapsto \quad C_1(x) \wedge \dots \wedge C_n(x) \rightarrow D(x)$$

$$\exists R . C \sqsubseteq D \quad \mapsto \quad R(x, y) \wedge C(y) \rightarrow D(x),$$

$$C(x) \wedge R^-(x, t_{\mathbb{E}}) \rightarrow R^-(x, t_{\mathbb{E} \sqcap D}) \wedge \bigwedge_{E \in \mathbb{E} \sqcap D} E(t_{\mathbb{E} \sqcap D})$$

for every conjunction  $\mathbb{E}$  of concept names

$$C \sqsubseteq \exists R . D \quad \mapsto \quad C(x) \rightarrow R(x, t_D) \wedge D(t_D)$$

$$R \sqsubseteq S \quad \mapsto \quad R(x, y) \rightarrow S(x, y), R^-(x, y) \rightarrow S^-(x, y)$$

# Materialisation Step: (Horn-)ELI

$$C_1 \sqcap \dots \sqcap C_n \sqsubseteq D \quad \mapsto \quad C_1(x) \wedge \dots \wedge C_n(x) \rightarrow D(x)$$

$$\exists R . C \sqsubseteq D \quad \mapsto \quad R(x, y) \wedge C(y) \rightarrow D(x),$$

$$C(x) \wedge R^-(x, t_{\mathbb{E}}) \rightarrow R^-(x, t_{\mathbb{E} \cap D}) \wedge \bigwedge_{E \in \mathbb{E} \cap D} E(t_{\mathbb{E} \cap D})$$

for every conjunction  $\mathbb{E}$  of concept names

$$C \sqsubseteq \exists R . D \quad \mapsto \quad C(x) \rightarrow R(x, t_D) \wedge D(t_D)$$

$$R \sqsubseteq S \quad \mapsto \quad R(x, y) \rightarrow S(x, y), R^-(x, y) \rightarrow S^-(x, y)$$



# Materialisation Step: Horn-ELI

$C \sqsubseteq \exists R.D \quad \exists R^-.E \sqsubseteq F \quad C(a)$   
 $D \sqsubseteq \exists S.C \quad \exists S^-.F \sqsubseteq E \quad E(a)$   
 $\quad \quad \quad \exists R.F \sqsubseteq G \quad C(b)$

# Materialisation Step: Horn-ELI

$$\begin{array}{lll} C \sqsubseteq \exists R.D & \exists R^-.E \sqsubseteq F & C(a) \\ D \sqsubseteq \exists S.C & \exists S^-.F \sqsubseteq E & E(a) \\ & \exists R.F \sqsubseteq G & C(b) \end{array}$$

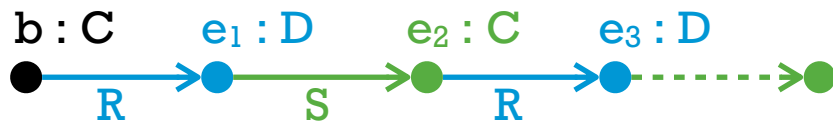
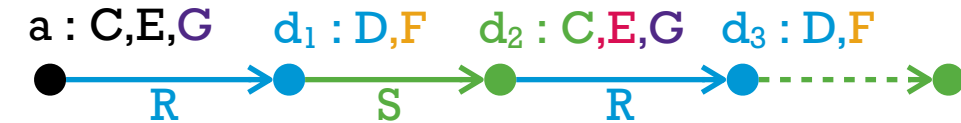

# Materialisation Step: Horn-ELI

$$C \sqsubseteq \exists R . D \quad \exists R^- . E \sqsubseteq F \quad C(a)$$

$$D \sqsubseteq \exists S . C \quad \exists S^- . F \sqsubseteq E \quad E(a)$$

$$\exists R . F \sqsubseteq G \quad C(b)$$

$$C(x) \rightarrow R(x, t_D) \wedge D(t_D)$$

$$D(x) \rightarrow S(x, t_C) \wedge C(t_C)$$

$$E(x) \wedge R(x, t_D) \rightarrow R(x, t_{D \sqcap F}) \wedge D(t_{D \sqcap F}) \wedge F(t_{D \sqcap F})$$

$$F(x) \wedge S(x, t_C) \rightarrow S(x, t_{C \sqcap E}) \wedge C(t_{C \sqcap E}) \wedge E(t_{C \sqcap E})$$

$$R(x, y) \wedge F(y) \rightarrow G(x)$$

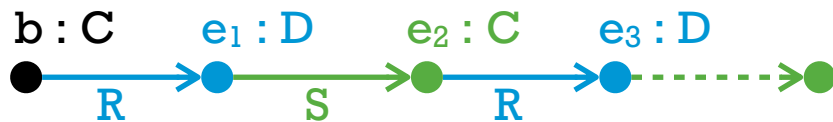
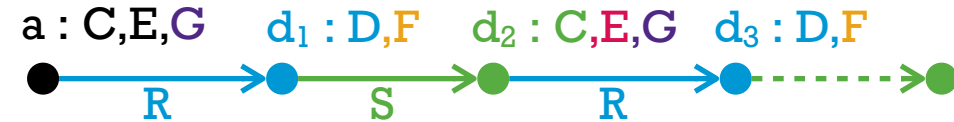

# Materialisation Step: Horn-ELI

$$\begin{array}{l}
 C \sqsubseteq \exists R.D \quad \exists R^-.E \sqsubseteq F \\
 D \sqsubseteq \exists S.C \quad \exists S^-.F \sqsubseteq E \\
 \exists R.F \sqsubseteq G
 \end{array}$$

$C(a)$

$E(a)$

$C(b)$

$$C(x) \rightarrow R(x, t_D) \wedge D(t_D)$$

$$D(x) \rightarrow S(x, t_C) \wedge C(t_C)$$

$$E(x) \wedge R(x, t_D) \rightarrow R(x, t_{D \sqcap F}) \wedge D(t_{D \sqcap F}) \wedge F(t_{D \sqcap F})$$

$$F(x) \wedge S(x, t_C) \rightarrow S(x, t_{C \sqcap E}) \wedge C(t_{C \sqcap E}) \wedge E(t_{C \sqcap E})$$

$$R(x, y) \wedge F(y) \rightarrow G(x)$$

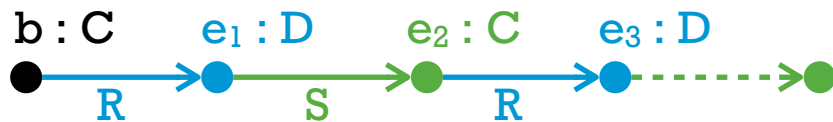
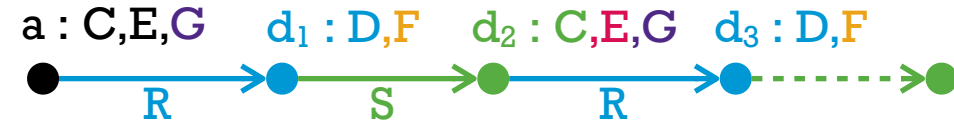

$a : C, E$

$b : C$

# Materialisation Step: Horn-ELI

$$\begin{array}{ll}
 C \sqsubseteq \exists R.D & \exists R^-.E \sqsubseteq F \\
 D \sqsubseteq \exists S.C & \exists S^-.F \sqsubseteq E \\
 & \exists R.F \sqsubseteq G
 \end{array}$$

$C(a)$

$E(a)$

$C(b)$

$$C(x) \rightarrow R(x, t_D) \wedge D(t_D)$$

$$D(x) \rightarrow S(x, t_C) \wedge C(t_C)$$

$$E(x) \wedge R(x, t_D) \rightarrow R(x, t_{D \sqcap F}) \wedge D(t_{D \sqcap F}) \wedge F(t_{D \sqcap F})$$

$$F(x) \wedge S(x, t_C) \rightarrow S(x, t_{C \sqcap E}) \wedge C(t_{C \sqcap E}) \wedge E(t_{C \sqcap E})$$

$$R(x, y) \wedge F(y) \rightarrow G(x)$$

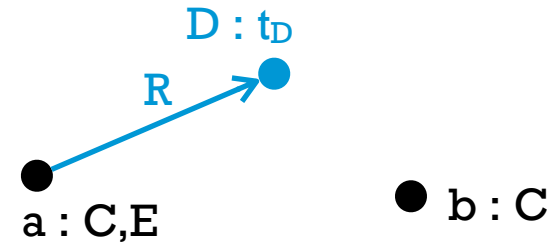
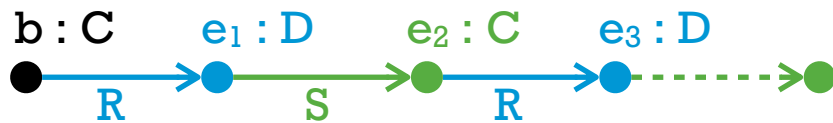
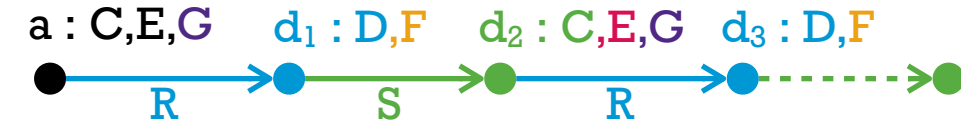

# Materialisation Step: Horn-ELI

$C \sqsubseteq \exists R. D$     $\exists R^-. E \sqsubseteq F$     $C(a)$   
 $D \sqsubseteq \exists S. C$     $\exists S^-. F \sqsubseteq E$     $E(a)$   
 $\exists R. F \sqsubseteq G$     $C(b)$

$C(x) \rightarrow R(x, t_D) \wedge D(t_D)$

$D(x) \rightarrow S(x, t_C) \wedge C(t_C)$

$E(x) \wedge R(x, t_D) \rightarrow R(x, t_{D \sqcap F}) \wedge D(t_{D \sqcap F}) \wedge F(t_{D \sqcap F})$

$F(x) \wedge S(x, t_C) \rightarrow S(x, t_{C \sqcap E}) \wedge C(t_{C \sqcap E}) \wedge E(t_{C \sqcap E})$

$R(x, y) \wedge F(y) \rightarrow G(x)$

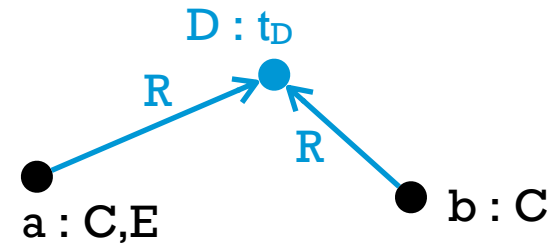
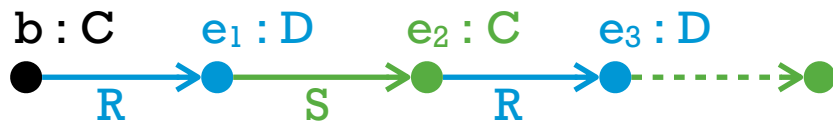
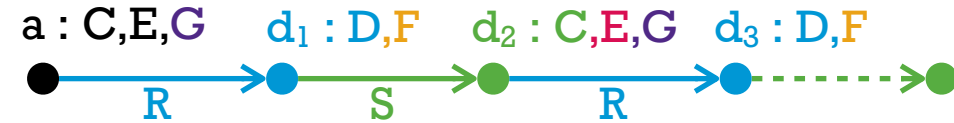

# Materialisation Step: Horn-ELI

$C \sqsubseteq \exists R. D$     $\exists R^-. E \sqsubseteq F$     $C(a)$   
 $D \sqsubseteq \exists S. C$     $\exists S^-. F \sqsubseteq E$     $E(a)$   
 $\exists R. F \sqsubseteq G$     $C(b)$

$C(x) \rightarrow R(x, t_D) \wedge D(t_D)$

$D(x) \rightarrow S(x, t_C) \wedge C(t_C)$

$E(x) \wedge R(x, t_D) \rightarrow R(x, t_{D \sqcap F}) \wedge D(t_{D \sqcap F}) \wedge F(t_{D \sqcap F})$

$F(x) \wedge S(x, t_C) \rightarrow S(x, t_{C \sqcap E}) \wedge C(t_{C \sqcap E}) \wedge E(t_{C \sqcap E})$

$R(x, y) \wedge F(y) \rightarrow G(x)$

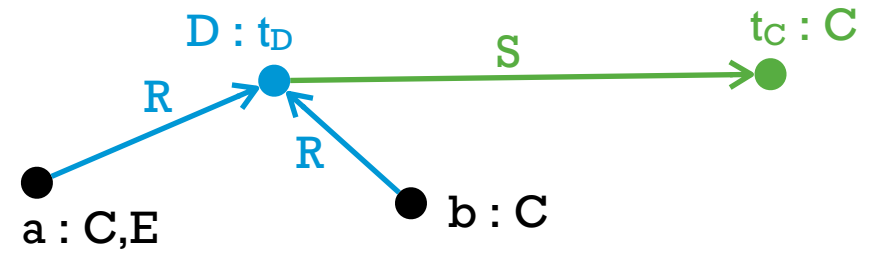
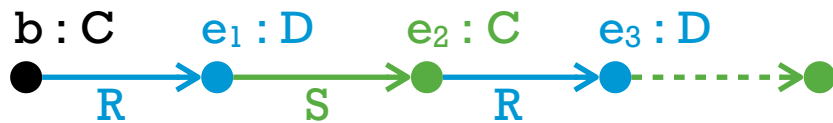
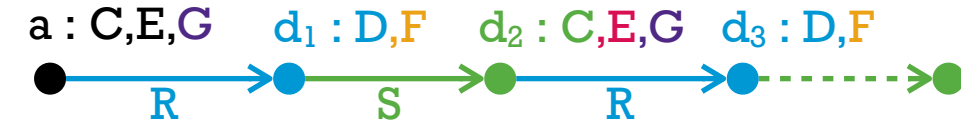

# Materialisation Step: Horn-ELI

$C \sqsubseteq \exists R. D$     $\exists R^-. E \sqsubseteq F$     $C(a)$   
 $D \sqsubseteq \exists S. C$     $\exists S^-. F \sqsubseteq E$     $E(a)$   
 $\exists R. F \sqsubseteq G$     $C(b)$

$C(x) \rightarrow R(x, t_D) \wedge D(t_D)$

$D(x) \rightarrow S(x, t_C) \wedge C(t_C)$

$E(x) \wedge R(x, t_D) \rightarrow R(x, t_{D \sqcap F}) \wedge D(t_{D \sqcap F}) \wedge F(t_{D \sqcap F})$

$F(x) \wedge S(x, t_C) \rightarrow S(x, t_{C \sqcap E}) \wedge C(t_{C \sqcap E}) \wedge E(t_{C \sqcap E})$

$R(x, y) \wedge F(y) \rightarrow G(x)$

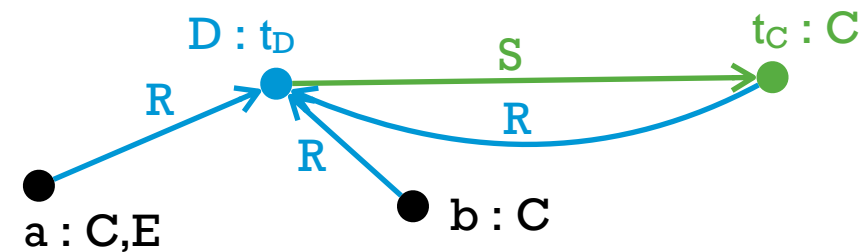
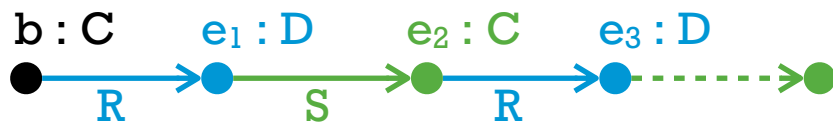
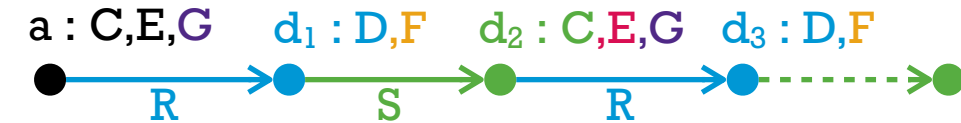



# Materialisation Step: Horn-ELI

$$C \sqsubseteq \exists R. D \quad \exists R^-. E \sqsubseteq F \quad C(a)$$

$$D \sqsubseteq \exists S. C \quad \exists S^-. F \sqsubseteq E \quad E(a)$$

$$\exists R. F \sqsubseteq G \quad C(b)$$

$$C(x) \rightarrow R(x, t_D) \wedge D(t_D)$$

$$D(x) \rightarrow S(x, t_C) \wedge C(t_C)$$

$$E(x) \wedge R(x, t_D) \rightarrow R(x, t_{D \sqcap F}) \wedge D(t_{D \sqcap F}) \wedge F(t_{D \sqcap F})$$

$$F(x) \wedge S(x, t_C) \rightarrow S(x, t_{C \sqcap E}) \wedge C(t_{C \sqcap E}) \wedge E(t_{C \sqcap E})$$

$$R(x, y) \wedge F(y) \rightarrow G(x)$$

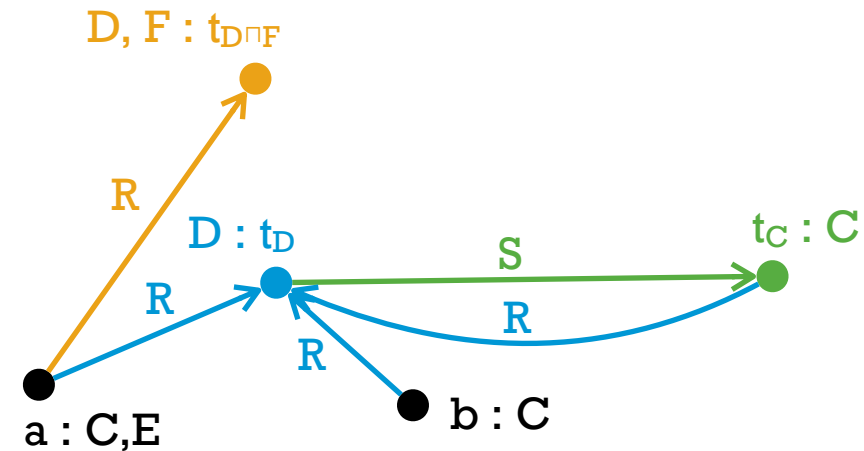
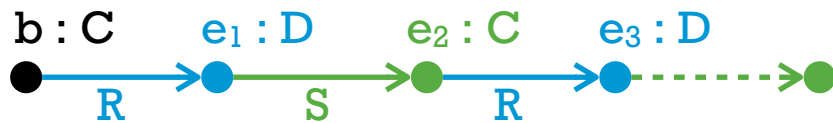
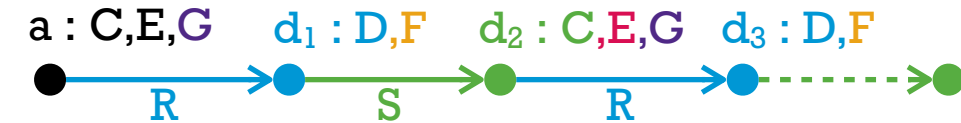

# Materialisation Step: Horn-ELI

$C \sqsubseteq \exists R. D$     $\exists R^-. E \sqsubseteq F$     $C(a)$   
 $D \sqsubseteq \exists S. C$     $\exists S^-. F \sqsubseteq E$     $E(a)$   
 $\exists R. F \sqsubseteq G$     $C(b)$

$C(x) \rightarrow R(x, t_D) \wedge D(t_D)$

$D(x) \rightarrow S(x, t_C) \wedge C(t_C)$

$E(x) \wedge R(x, t_D) \rightarrow R(x, t_{D \sqcap F}) \wedge D(t_{D \sqcap F}) \wedge F(t_{D \sqcap F})$

$F(x) \wedge S(x, t_C) \rightarrow S(x, t_{C \sqcap E}) \wedge C(t_{C \sqcap E}) \wedge E(t_{C \sqcap E})$

$R(x, y) \wedge F(y) \rightarrow G(x)$

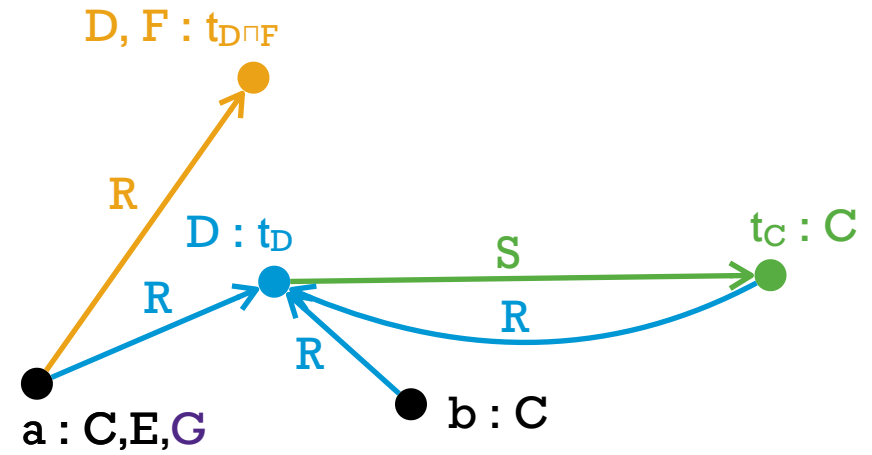
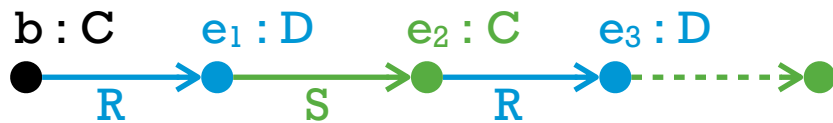
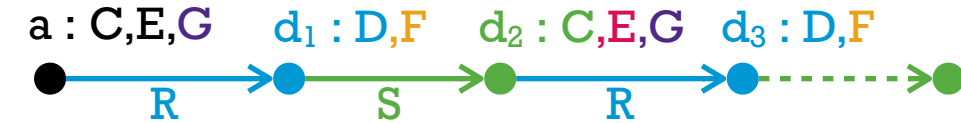

# Materialisation Step: Horn-ELI

$C \sqsubseteq \exists R. D$     $\exists R^-. E \sqsubseteq F$     $C(a)$   
 $D \sqsubseteq \exists S. C$     $\exists S^-. F \sqsubseteq E$     $E(a)$   
 $\exists R. F \sqsubseteq G$     $C(b)$

$C(x) \rightarrow R(x, t_D) \wedge D(t_D)$

$D(x) \rightarrow S(x, t_C) \wedge C(t_C)$

$E(x) \wedge R(x, t_D) \rightarrow R(x, t_{D \sqcap F}) \wedge D(t_{D \sqcap F}) \wedge F(t_{D \sqcap F})$

$F(x) \wedge S(x, t_C) \rightarrow S(x, t_{C \sqcap E}) \wedge C(t_{C \sqcap E}) \wedge E(t_{C \sqcap E})$

$R(x, y) \wedge F(y) \rightarrow G(x)$

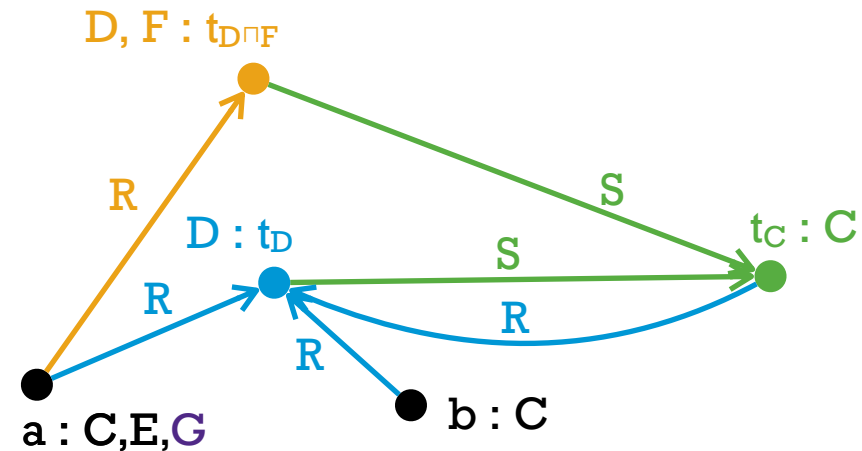
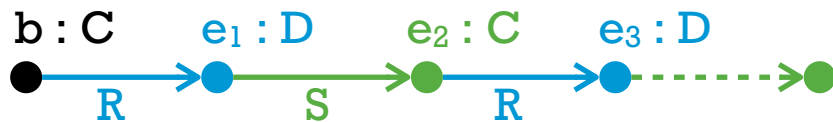
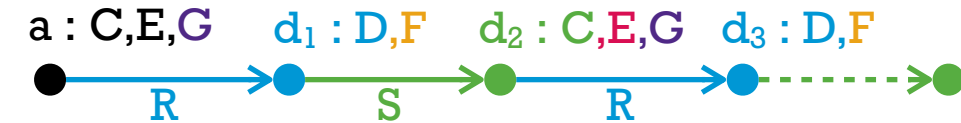

# Materialisation Step: Horn-ELI

$C \sqsubseteq \exists R.D$     $\exists R^-.E \sqsubseteq F$     $C(a)$   
 $D \sqsubseteq \exists S.C$     $\exists S^-.F \sqsubseteq E$     $E(a)$   
 $\exists R.F \sqsubseteq G$     $C(b)$

$C(x) \rightarrow R(x, t_D) \wedge D(t_D)$

$D(x) \rightarrow S(x, t_C) \wedge C(t_C)$

$E(x) \wedge R(x, t_D) \rightarrow R(x, t_{D \sqcap F}) \wedge D(t_{D \sqcap F}) \wedge F(t_{D \sqcap F})$

$F(x) \wedge S(x, t_C) \rightarrow S(x, t_{C \sqcap E}) \wedge C(t_{C \sqcap E}) \wedge E(t_{C \sqcap E})$

$R(x, y) \wedge F(y) \rightarrow G(x)$

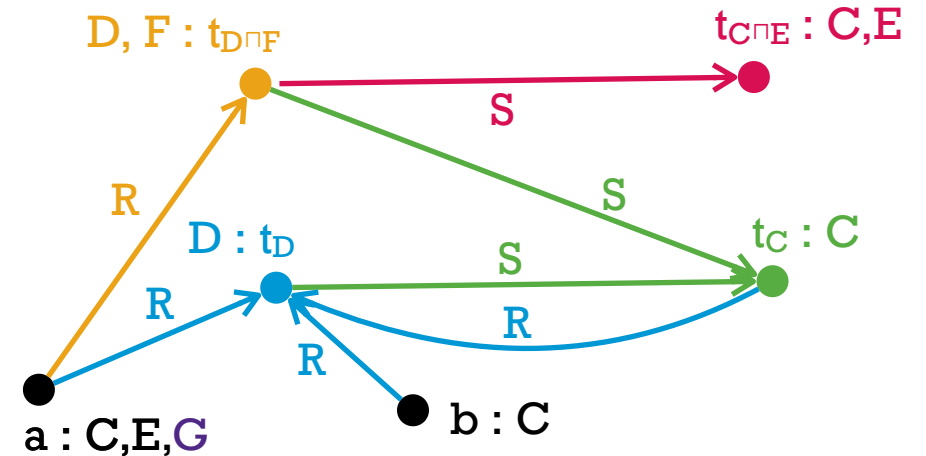
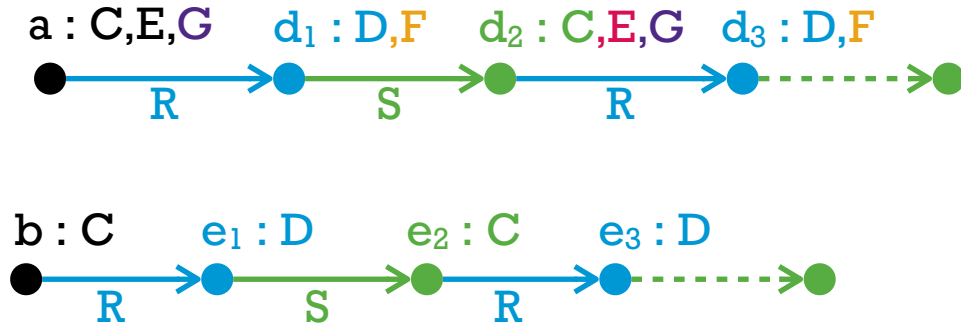

# Materialisation Step: Horn-ELI

$C \sqsubseteq \exists R. D$     $\exists R^-. E \sqsubseteq F$     $C(a)$   
 $D \sqsubseteq \exists S. C$     $\exists S^-. F \sqsubseteq E$     $E(a)$   
 $\exists R. F \sqsubseteq G$     $C(b)$

$C(x) \rightarrow R(x, t_D) \wedge D(t_D)$

$D(x) \rightarrow S(x, t_C) \wedge C(t_C)$

$E(x) \wedge R(x, t_D) \rightarrow R(x, t_{D \sqcap F}) \wedge D(t_{D \sqcap F}) \wedge F(t_{D \sqcap F})$

$F(x) \wedge S(x, t_C) \rightarrow S(x, t_{C \sqcap E}) \wedge C(t_{C \sqcap E}) \wedge E(t_{C \sqcap E})$

$R(x, y) \wedge F(y) \rightarrow G(x)$

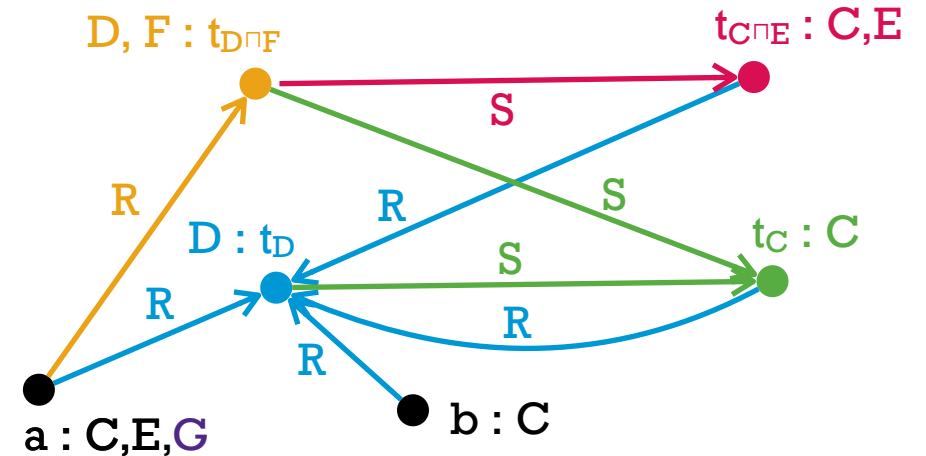
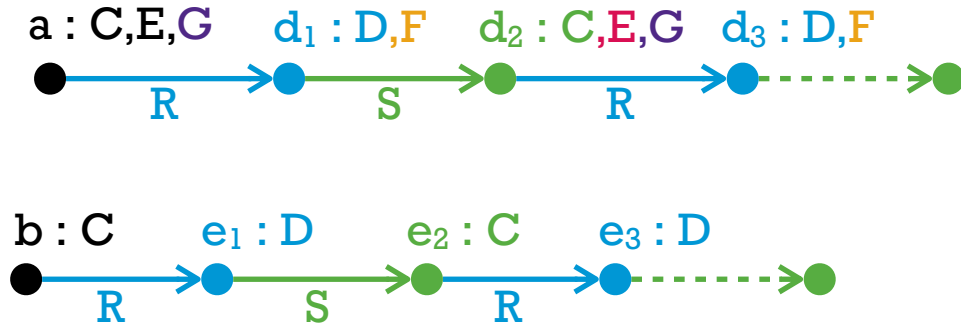

# Materialisation Step: Horn-ELI

$C \sqsubseteq \exists R.D$     $\exists R^-.E \sqsubseteq F$     $C(a)$   
 $D \sqsubseteq \exists S.C$     $\exists S^-.F \sqsubseteq E$     $E(a)$   
 $\exists R.F \sqsubseteq G$     $C(b)$

$C(x) \rightarrow R(x, t_D) \wedge D(t_D)$

$D(x) \rightarrow S(x, t_C) \wedge C(t_C)$

$E(x) \wedge R(x, t_D) \rightarrow R(x, t_{D \sqcap F}) \wedge D(t_{D \sqcap F}) \wedge F(t_{D \sqcap F})$

$F(x) \wedge S(x, t_C) \rightarrow S(x, t_{C \sqcap E}) \wedge C(t_{C \sqcap E}) \wedge E(t_{C \sqcap E})$

$R(x, y) \wedge F(y) \rightarrow G(x)$

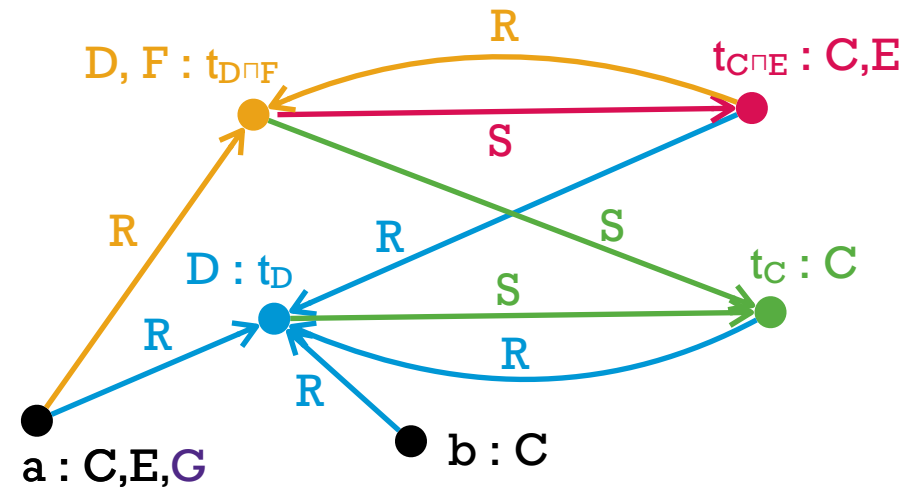
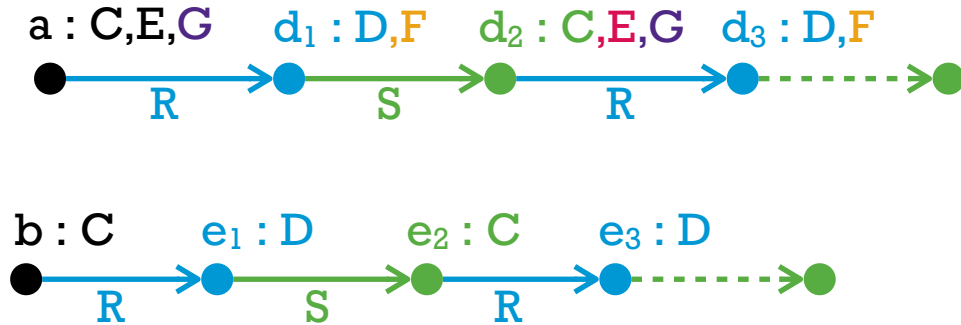

# Materialisation Step: Horn-ELI

$C \sqsubseteq \exists R.D$     $\exists R^-.E \sqsubseteq F$     $C(a)$   
 $D \sqsubseteq \exists S.C$     $\exists S^-.F \sqsubseteq E$     $E(a)$   
 $\exists R.F \sqsubseteq G$     $C(b)$

$C(x) \rightarrow R(x, t_D) \wedge D(t_D)$

$D(x) \rightarrow S(x, t_C) \wedge C(t_C)$

$E(x) \wedge R(x, t_D) \rightarrow R(x, t_{D \sqcap F}) \wedge D(t_{D \sqcap F}) \wedge F(t_{D \sqcap F})$

$F(x) \wedge S(x, t_C) \rightarrow S(x, t_{C \sqcap E}) \wedge C(t_{C \sqcap E}) \wedge E(t_{C \sqcap E})$

$R(x, y) \wedge F(y) \rightarrow G(x)$

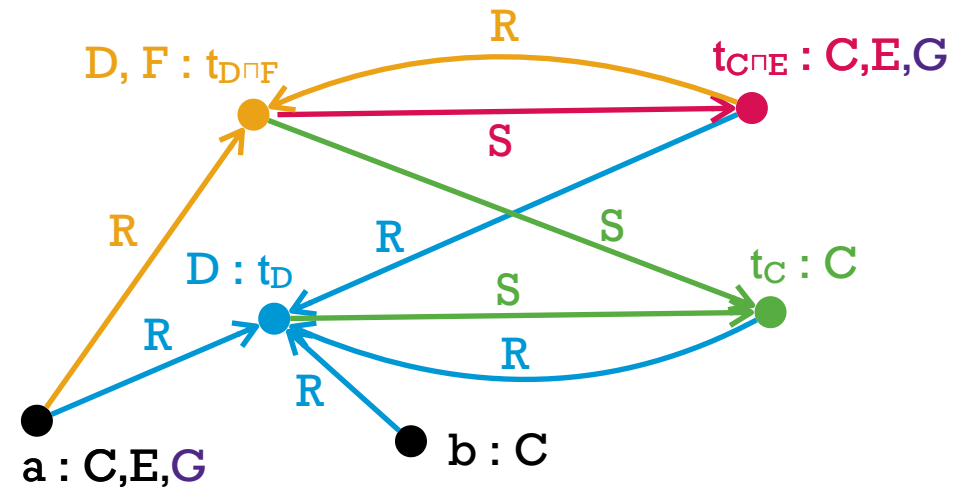
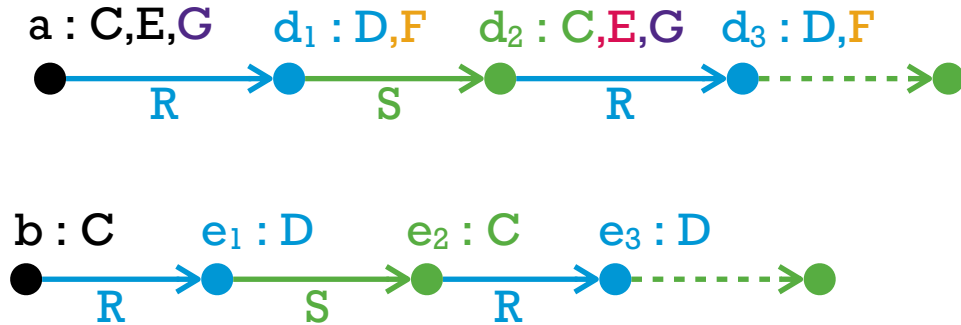

# Materialisation Step: Horn-ELI

$C \sqsubseteq \exists R.D$     $\exists R^-.E \sqsubseteq F$     $C(a)$   
 $D \sqsubseteq \exists S.C$     $\exists S^-.F \sqsubseteq E$     $E(a)$   
 $\exists R.F \sqsubseteq G$     $C(b)$

$C(x) \rightarrow R(x, t_D) \wedge D(t_D)$

$D(x) \rightarrow S(x, t_C) \wedge C(t_C)$

$E(x) \wedge R(x, t_D) \rightarrow R(x, t_{D \sqcap F}) \wedge D(t_{D \sqcap F}) \wedge F(t_{D \sqcap F})$

$F(x) \wedge S(x, t_C) \rightarrow S(x, t_{C \sqcap E}) \wedge C(t_{C \sqcap E}) \wedge E(t_{C \sqcap E})$

$R(x, y) \wedge F(y) \rightarrow G(x)$

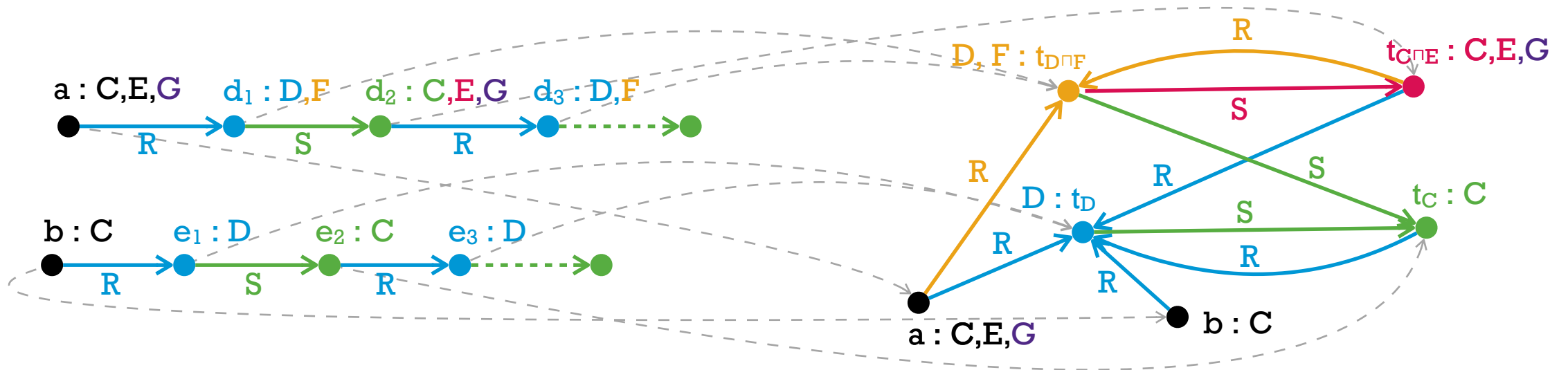



# Materialisation Step: Horn-ELI

$C \sqsubseteq \exists R.D$     $\exists R^-.E \sqsubseteq F$     $C(a)$   
 $D \sqsubseteq \exists S.C$     $\exists S^-.F \sqsubseteq E$     $E(a)$   
 $\exists R.F \sqsubseteq G$     $C(b)$

$C(x) \rightarrow R(x, t_D) \wedge D(t_D)$   
 $D(x) \rightarrow S(x, t_C) \wedge C(t_C)$

$E(x) \wedge R(x, t_D) \rightarrow R(x, t_{D \cap F}) \wedge D(t_{D \cap F}) \wedge F(t_{D \cap F})$   
 $F(x) \wedge S(x, t_C) \rightarrow S(x, t_{C \cap E}) \wedge C(t_{C \cap E}) \wedge E(t_{C \cap E})$   
 $R(x, y) \wedge F(y) \rightarrow G(x)$

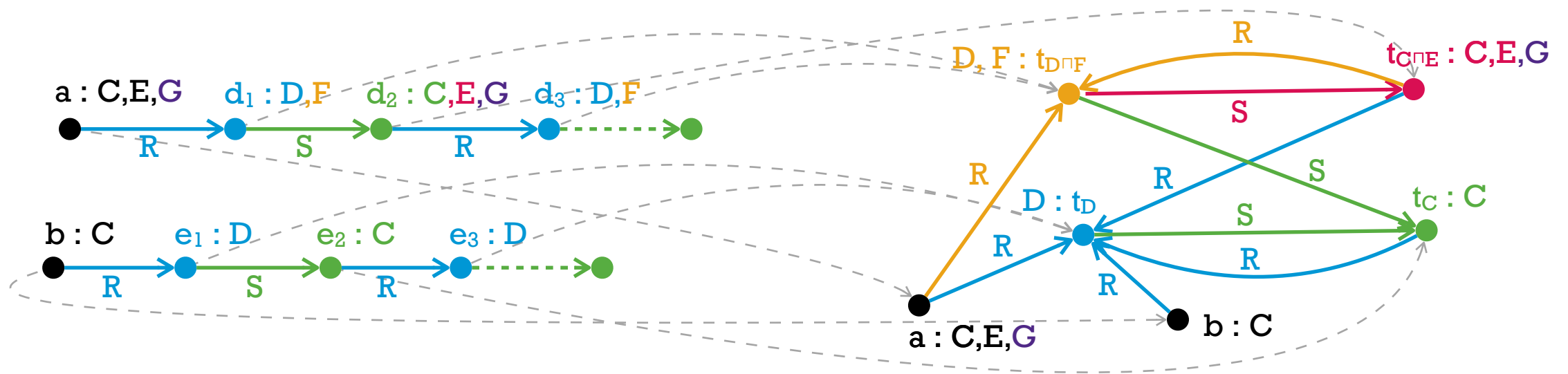

$$q_1 = \exists y, w . C(a) \wedge R(a, y) \wedge S(y, w) \wedge G(w)$$

# Materialisation Step: Horn-ELI

$C \sqsubseteq \exists R . D$     $\exists R^- . E \sqsubseteq F$     $C(a)$   
 $D \sqsubseteq \exists S . C$     $\exists S^- . F \sqsubseteq E$     $E(a)$   
 $\exists R . F \sqsubseteq G$     $C(b)$

$C(x) \rightarrow R(x, t_D) \wedge D(t_D)$

$D(x) \rightarrow S(x, t_C) \wedge C(t_C)$

$E(x) \wedge R(x, t_D) \rightarrow R(x, t_{D \cap F}) \wedge D(t_{D \cap F}) \wedge F(t_{D \cap F})$

$F(x) \wedge S(x, t_C) \rightarrow S(x, t_{C \cap E}) \wedge C(t_{C \cap E}) \wedge E(t_{C \cap E})$

$R(x, y) \wedge F(y) \rightarrow G(x)$

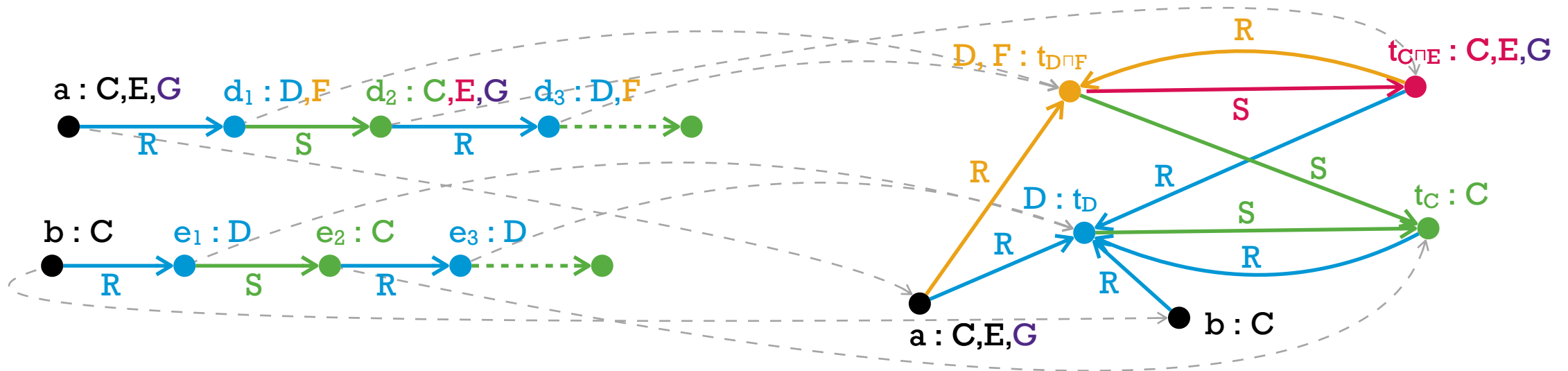

$q_1 = \exists y, w . C(a) \wedge R(a, y) \wedge S(y, w) \wedge G(w)$

$q_2 = \exists y, w . C(a) \wedge R(a, y) \wedge S(y, w) \wedge R(w, y)$

# Materialisation Step: Horn-ALCHOIQ

$$\mathcal{R}_{\text{Top}} = \{C(x) \rightarrow T(x) \mid C \in N_C\} \cup \{\mathbb{R}(x, y) \rightarrow T(x) \wedge T(y) \mid \mathbb{R} \in N_R^\square\}$$

$$\mathcal{R}_{\text{Role}} = \{\mathbb{R}(x, y) \wedge N(y) \rightarrow \mathbb{R}^-(x, y) \mid \mathbb{R} \in N_R^\square\} \cup \\ \{\mathbb{R}(x, y) \rightarrow R(x, y) \mid \mathbb{R} \in N_R^\square, R \in N_R\}$$

$$\mathcal{R}_{\text{Nm}} = \{N(a), T(a) \mid a \in N_I\}$$

$$\mathcal{R}_{\text{Eq}} = \{x \approx y \rightarrow y \approx x, x \approx y \wedge y \approx z \rightarrow x \approx z\} \cup \\ \{C(x) \wedge x \approx y \rightarrow C(y) \mid C \in N_C^+\} \cup \\ \{\mathbb{R}(x, y) \wedge x \approx z \rightarrow \mathbb{R}(z, y), \mathbb{R}(x, y) \wedge y \approx z \rightarrow \mathbb{R}(x, z) \mid \mathbb{R} \in N_R^\square\}$$

# Materialisation Step: Horn-ALCHOIQ

$$C_1 \sqcap \dots \sqcap C_n \sqsubseteq D \quad \mapsto \quad C_1(x) \wedge \dots \wedge C_n(x) \rightarrow D(x)$$

$$\exists R. C \sqsubseteq D \quad \mapsto \quad R(x, y) \wedge C(y) \rightarrow D(x),$$

$$C(x) \wedge \mathbb{R}^-(x, t_{\mathbb{E}}) \rightarrow \mathbb{R}^-(x, t_{\mathbb{E} \cap D}) \wedge \bigwedge_{E \in \mathbb{E} \cap D} E(t_{\mathbb{E} \cap D})$$

for every  $\mathbb{R} \in N_R^\sqcap$  with  $R \in \mathbb{R}$  and  $\mathbb{E} \in N_C^\sqcap$

$$C \sqsubseteq \exists R. D \quad \mapsto \quad C(x) \rightarrow R(x, t_D) \wedge D(t_D)$$

$$R \sqsubseteq S \quad \mapsto \quad \mathbb{R}(x, y) \rightarrow (\mathbb{R} \sqcap S)(x, y), \mathbb{R}^-(x, y) \rightarrow (\mathbb{R}^- \sqcap S^-)(x, y)$$

for every  $\mathbb{R} \in N_R^\sqcap$  with  $R \in \mathbb{R}$

$$C \sqsubseteq \{a\} \quad \mapsto \quad C(x) \rightarrow x \approx a$$

# Materialisation Step: Horn-ALCHOIQ

$$C \sqsubseteq \leq 1R.D \mapsto$$

For all  $\mathbb{R}, \mathbb{S} \in N_R^\sqcap$  with  $R \in \mathbb{R}$  and  $R \in \mathbb{S}$ , and all  $\mathbb{E}, \mathbb{F} \in N_C^\sqcap$

$$D(y) \wedge R^-(y, x) \wedge C(x) \wedge R(x, z) \wedge D(z) \wedge N(z) \rightarrow y \approx z$$

$$C(x) \wedge \mathbb{R}(x, t_{\mathbb{E}}) \wedge D(t_{\mathbb{E}}) \wedge \mathbb{S}(x, t_{\mathbb{F}}) \wedge F(t_{\mathbb{F}}) \rightarrow (\mathbb{R} \sqcap \mathbb{S})(x, t_{\mathbb{E} \sqcap \mathbb{F}}) \wedge \bigwedge_{X \in \mathbb{E} \sqcap \mathbb{F}} X(t_{\mathbb{E} \sqcap \mathbb{F}})$$

$$D(y) \wedge \mathbb{R}^-(y, x) \wedge C(x) \wedge \mathbb{S}(x, t_{\mathbb{E}}) \wedge D(t_{\mathbb{E}}) \rightarrow \bigwedge_{X \in \mathbb{E}} X(y) \wedge (\mathbb{R}^- \sqcap \mathbb{S}^-)(y, x)$$

$$D(y) \wedge R^-(y, x) \wedge C(x) \wedge N(x) \rightarrow N(y)$$

# Materialisation Step: Horn-ALCHOIQ

$$C \sqsubseteq \leq 1R . D \mapsto$$

For all  $\mathbb{R}, \mathbb{S} \in N_R^\sqcap$  with  $R \in \mathbb{R}$  and  $R \in \mathbb{S}$ , and all  $\mathbb{E}, \mathbb{F} \in N_C^\sqcap$

$$D(y) \wedge R^-(y, x) \wedge C(x) \wedge R(x, z) \wedge D(z) \wedge N(z) \rightarrow y \approx z$$

$$C(x) \wedge \mathbb{R}(x, t_{\mathbb{E}}) \wedge D(t_{\mathbb{E}}) \wedge \mathbb{S}(x, t_{\mathbb{F}}) \wedge F(t_{\mathbb{F}}) \rightarrow (\mathbb{R} \sqcap \mathbb{S})(x, t_{\mathbb{E} \sqcap \mathbb{F}}) \wedge \bigwedge_{X \in \mathbb{E} \sqcap \mathbb{F}} X(t_{\mathbb{E} \sqcap \mathbb{F}})$$

$$D(y) \wedge \mathbb{R}^-(y, x) \wedge C(x) \wedge \mathbb{S}(x, t_{\mathbb{E}}) \wedge D(t_{\mathbb{E}}) \rightarrow \bigwedge_{X \in \mathbb{E}} X(y) \wedge (\mathbb{R}^- \sqcap \mathbb{S}^-)(y, x)$$

$$D(y) \wedge R^-(y, x) \wedge C(x) \wedge N(x) \rightarrow N(y)$$

# Materialisation Step: Horn-ALCHOIQ

$C \sqsubseteq \leq 1 R . D \mapsto$

For all  $\mathbb{R}, \mathbb{S} \in N_R^\sqcap$  with  $R \in \mathbb{R}$  and  $R \in \mathbb{S}$ , and all  $\mathbb{E}, \mathbb{F} \in N_C^\sqcap$

$$C(x) \wedge \mathbb{R}(x, t_{\mathbb{E}}) \wedge D(t_{\mathbb{E}}) \wedge \mathbb{S}(x, t_{\mathbb{F}}) \wedge F(t_{\mathbb{F}}) \rightarrow (\mathbb{R} \sqcap \mathbb{S})(x, t_{\mathbb{E} \sqcap \mathbb{F}}) \wedge \bigwedge_{X \in \mathbb{E} \sqcap \mathbb{F}} X(t_{\mathbb{E} \sqcap \mathbb{F}})$$

# Materialisation Step: Horn-ALCHOIQ

$C \sqsubseteq \leq 1 R . D \mapsto$

For all  $\mathbb{R}, \mathbb{S} \in N_R^\sqcap$  with  $R \in \mathbb{R}$  and  $R \in \mathbb{S}$ , and all  $\mathbb{E}, \mathbb{F} \in N_C^\sqcap$

$$C(x) \wedge \mathbb{R}(x, t_{\mathbb{E}}) \wedge D(t_{\mathbb{E}}) \wedge \mathbb{S}(x, t_{\mathbb{F}}) \wedge F(t_{\mathbb{F}}) \rightarrow (\mathbb{R} \sqcap \mathbb{S})(x, t_{\mathbb{E} \sqcap \mathbb{F}}) \wedge \bigwedge_{X \in \mathbb{E} \sqcap \mathbb{F}} X(t_{\mathbb{E} \sqcap \mathbb{F}})$$

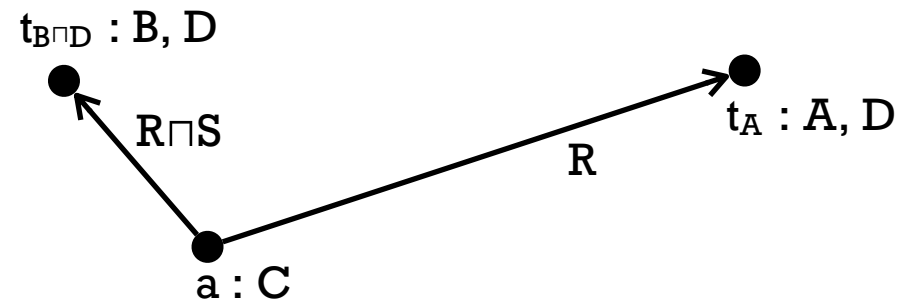



# Materialisation Step: Horn-ALCHOIQ

$C \sqsubseteq \leq 1 R . D \mapsto$

For all  $\mathbb{R}, \mathbb{S} \in N_R^\sqcap$  with  $R \in \mathbb{R}$  and  $R \in \mathbb{S}$ , and all  $\mathbb{E}, \mathbb{F} \in N_C^\sqcap$

$$C(x) \wedge \mathbb{R}(x, t_{\mathbb{E}}) \wedge D(t_{\mathbb{E}}) \wedge \mathbb{S}(x, t_{\mathbb{F}}) \wedge F(t_{\mathbb{F}}) \rightarrow (\mathbb{R} \sqcap \mathbb{S})(x, t_{\mathbb{E} \sqcap \mathbb{F}}) \wedge \bigwedge_{X \in \mathbb{E} \sqcap \mathbb{F}} X(t_{\mathbb{E} \sqcap \mathbb{F}})$$

$$C(x) \wedge (R \sqcap S)(x, t_{B \sqcap D}) \wedge D(t_{B \sqcap D})$$

$$\wedge R(x, t_A) \wedge D(t_A) \rightarrow (R \sqcap S)(x, t_{A \sqcap B \sqcap D}) \wedge A(t_{A \sqcap B \sqcap D}) \wedge B(t_{A \sqcap B \sqcap D}) \wedge D(t_{A \sqcap B \sqcap D})$$

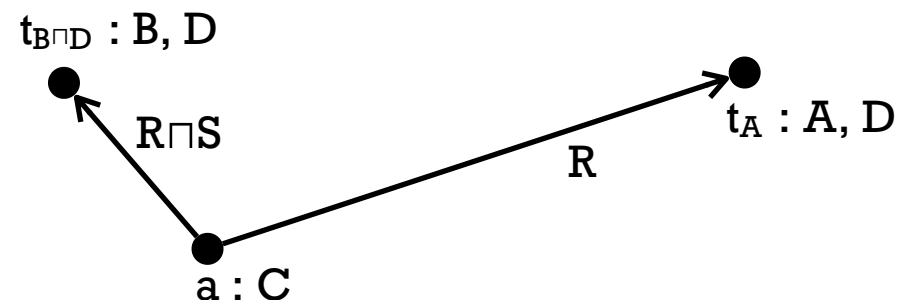

# Materialisation Step: Horn-ALCHOIQ

$C \sqsubseteq \leq 1 R . D \mapsto$

For all  $\mathbb{R}, \mathbb{S} \in N_R^\sqcap$  with  $R \in \mathbb{R}$  and  $R \in \mathbb{S}$ , and all  $\mathbb{E}, \mathbb{F} \in N_C^\sqcap$

$$C(x) \wedge \mathbb{R}(x, t_{\mathbb{E}}) \wedge D(t_{\mathbb{E}}) \wedge \mathbb{S}(x, t_{\mathbb{F}}) \wedge F(t_{\mathbb{F}}) \rightarrow (\mathbb{R} \sqcap \mathbb{S})(x, t_{\mathbb{E} \sqcap \mathbb{F}}) \wedge \bigwedge_{X \in \mathbb{E} \sqcap \mathbb{F}} X(t_{\mathbb{E} \sqcap \mathbb{F}})$$

$$C(x) \wedge (R \sqcap S)(x, t_{B \sqcap D}) \wedge D(t_{B \sqcap D})$$

$$\wedge R(x, t_A) \wedge D(t_A) \rightarrow (R \sqcap S)(x, t_{A \sqcap B \sqcap D}) \wedge A(t_{A \sqcap B \sqcap D}) \wedge B(t_{A \sqcap B \sqcap D}) \wedge D(t_{A \sqcap B \sqcap D})$$

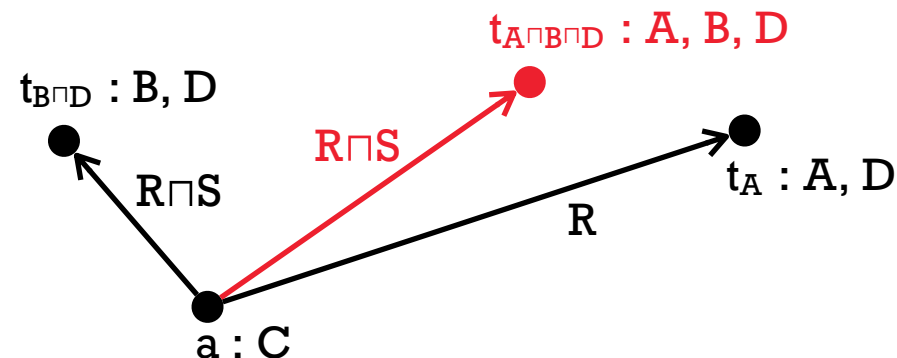

# Evaluation

# Materialisation Step: Implementation and Evaluation

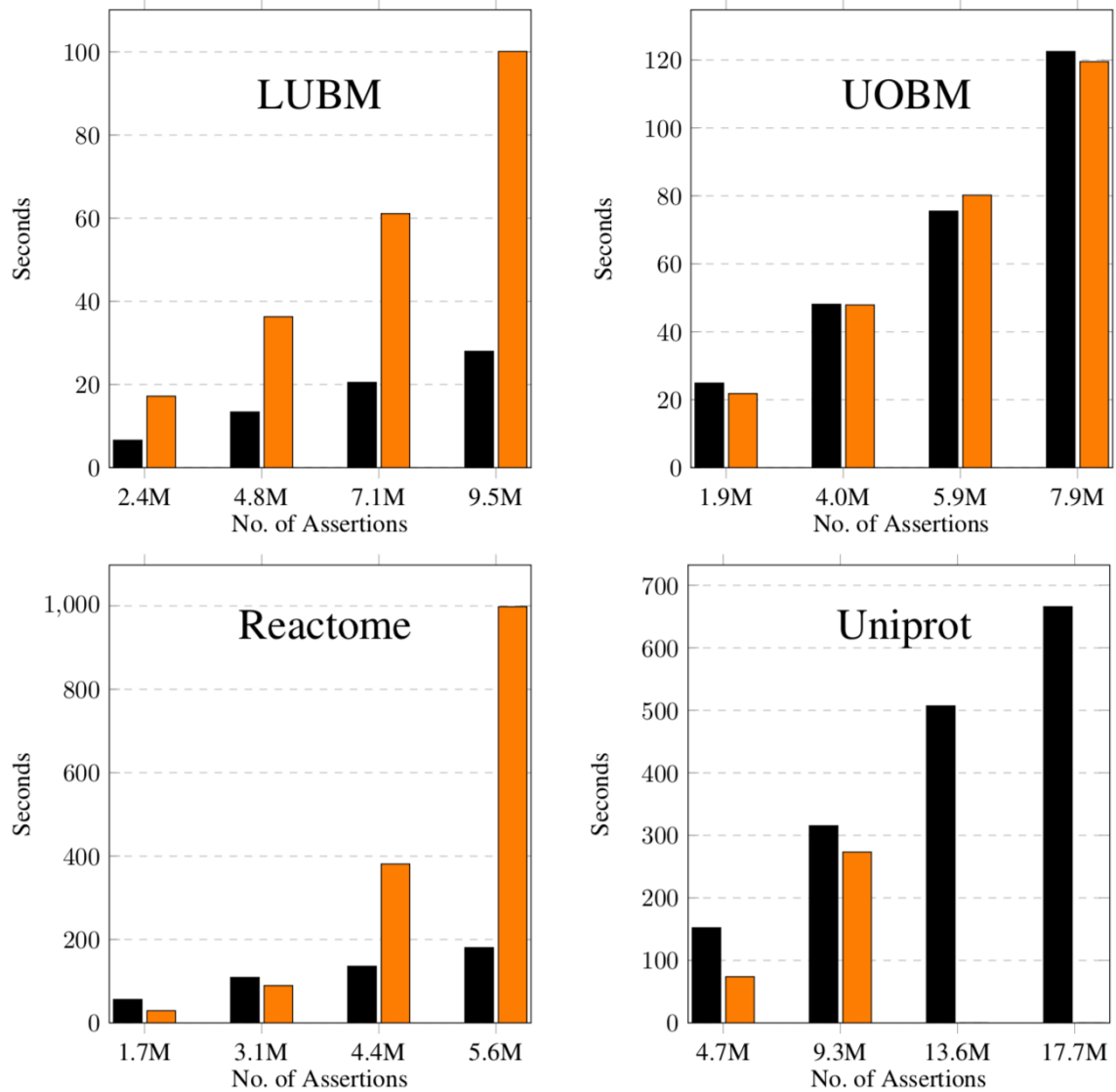

# Materialisation Step: Implementation and Evaluation

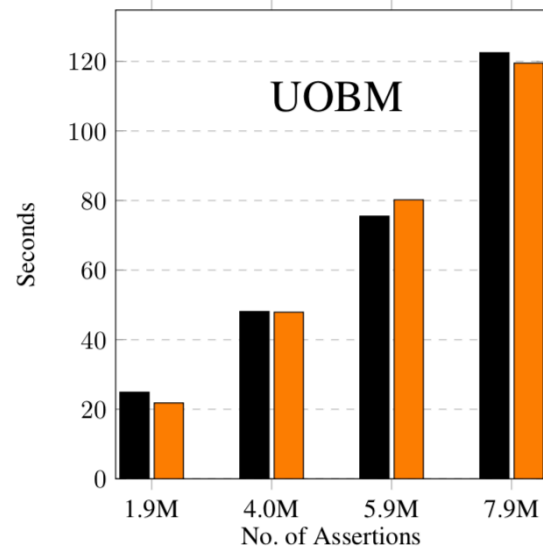
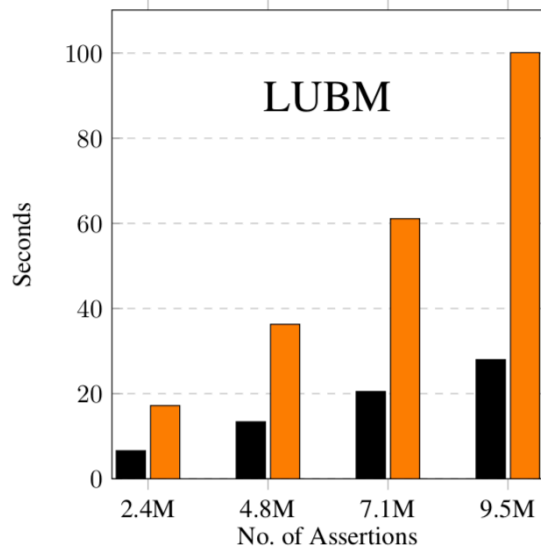

Materialisation Step

Konclude

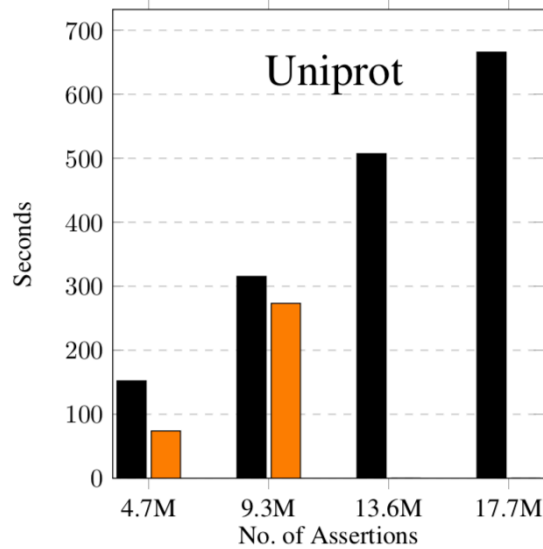
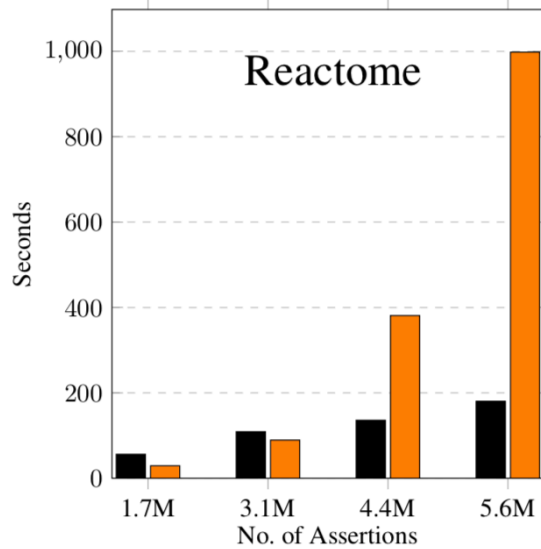

# Materialisation Step: Implementation and Evaluation

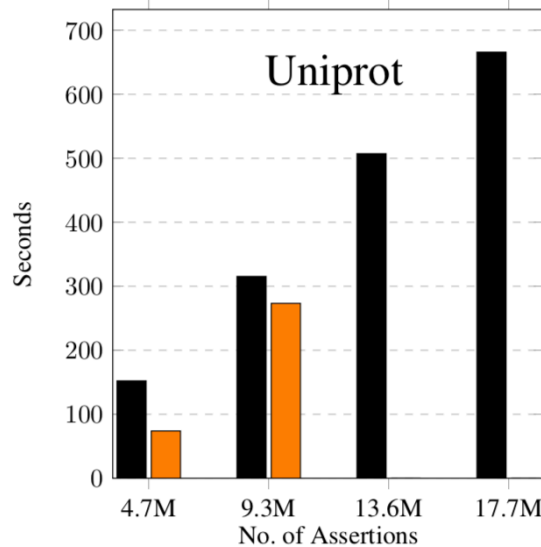
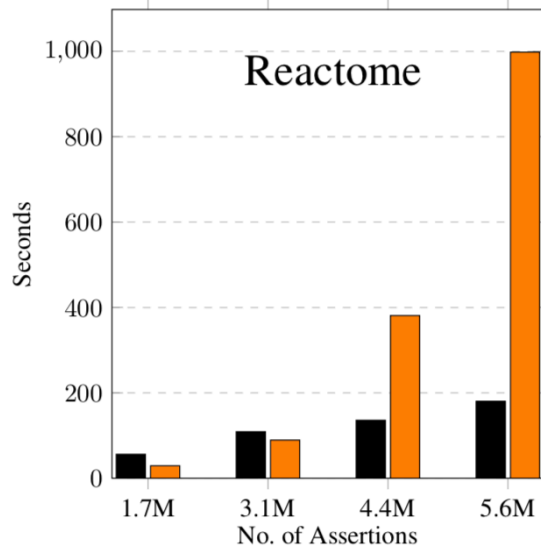
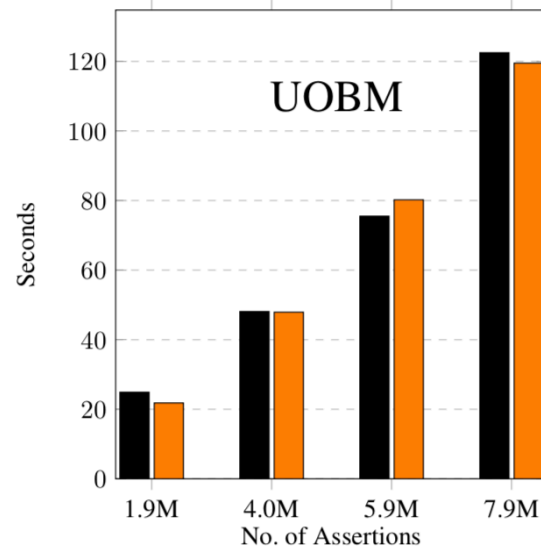
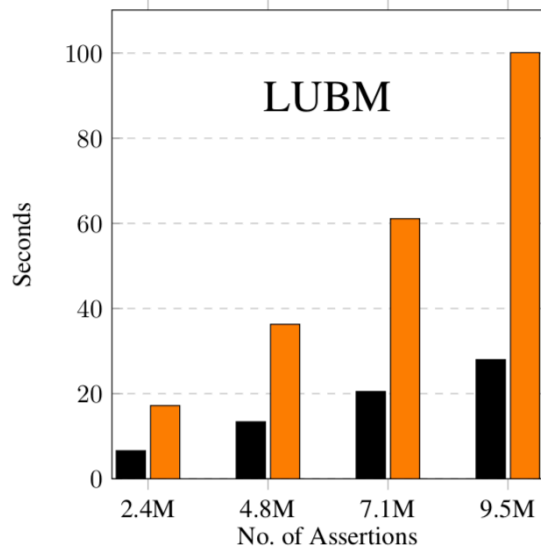

■ Materialisation Step  
■ Konclude

\* Use RDFox as a Datalog engine and add rules on demand

# Materialisation Step: Implementation and Evaluation

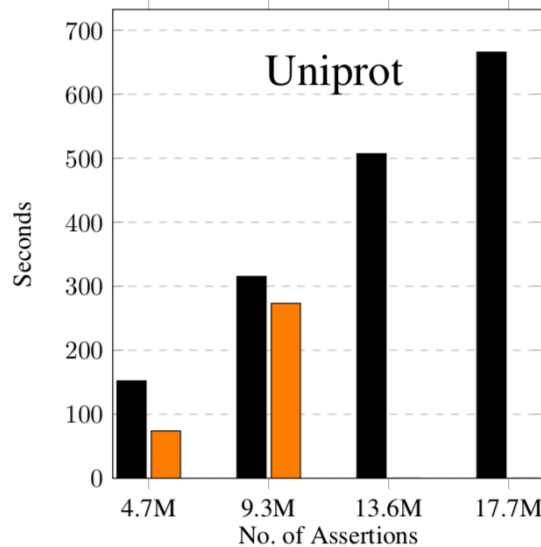
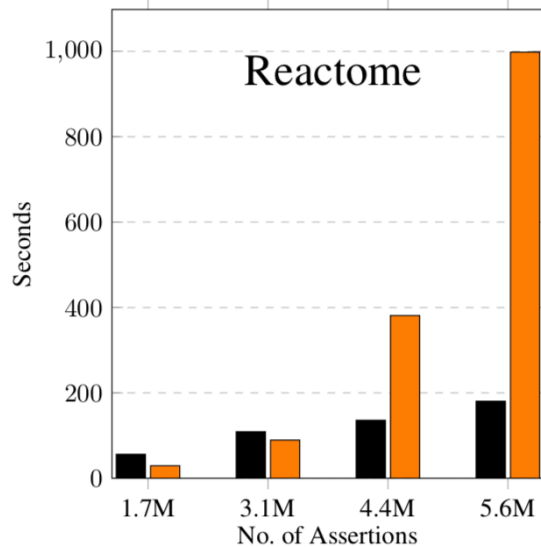
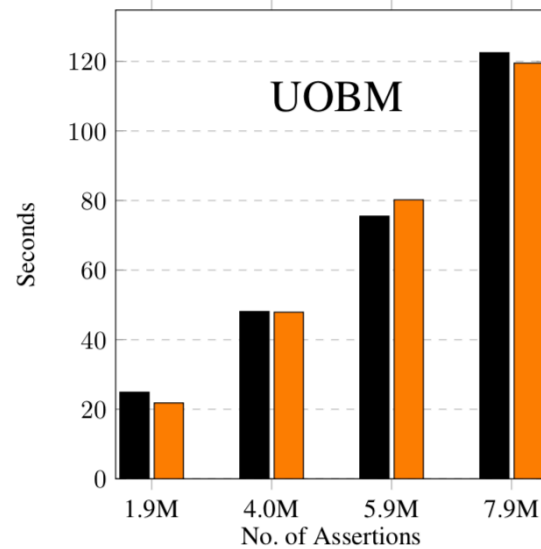
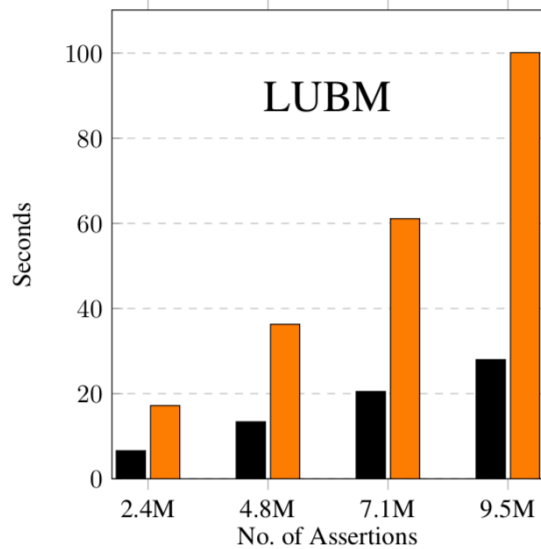

■ Materialisation Step  
■ Konclude

\* Use RDFox as a Datalog engine and add rules on demand

\* Rule count per ontology:  
108+6 (LUBM), 254+19 (UOBM),  
481+14 (Reactome), 317+59 (Uniprot)

# Materialisation Step: Implementation and Evaluation

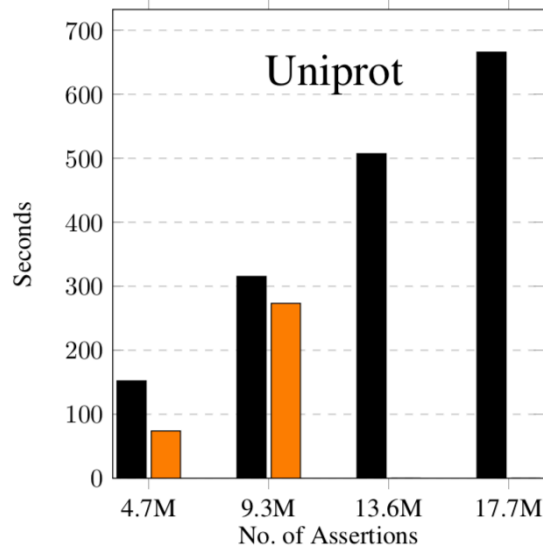
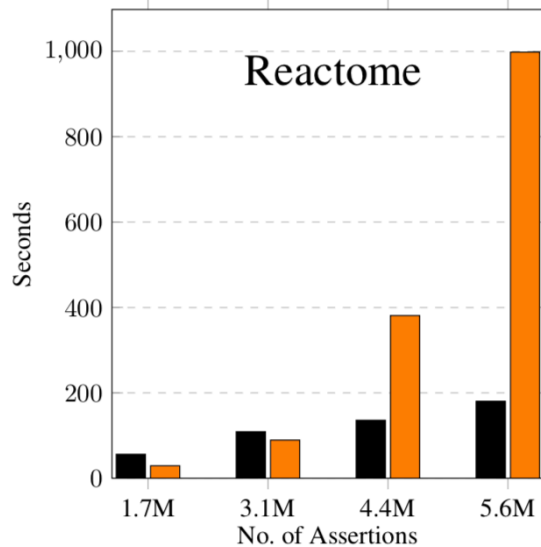
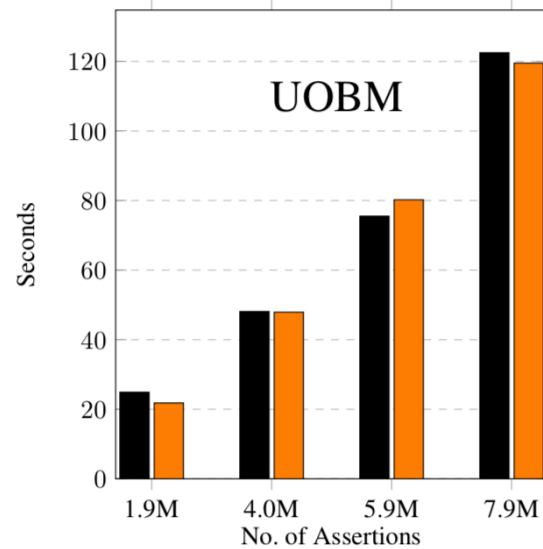
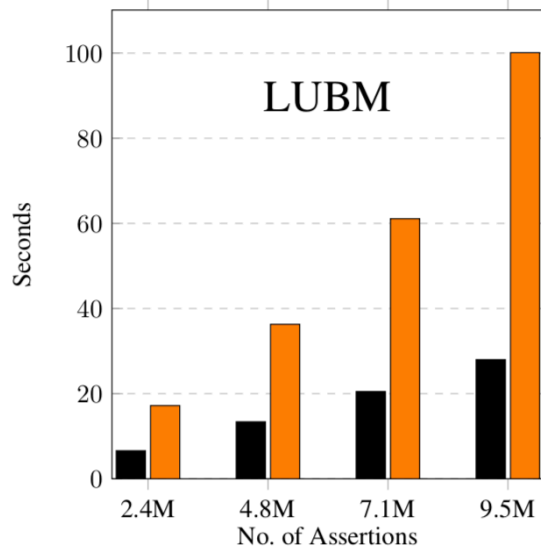

■ Materialisation Step  
■ Konclude

- \* Use RDFox as a Datalog engine and add rules on demand
- \* Rule count per ontology:  
108+6 (LUBM), 254+19 (UOBM),  
481+14 (Reactome), 317+59 (Uniprot)
- \* RDFox uses renaming to deal with equality.



# The Combined Approach to Query Answering in Horn-ALCHOIQ

David Carral, Irina Dragoste, Markus Krötzsch  
Knowledge-Based Systems Group at

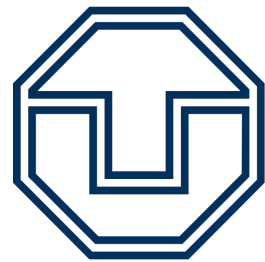

**TECHNISCHE  
UNIVERSITÄT  
DRESDEN**